

topline®



Meble inspirowane naturą  
i jej prostotą

*„Ludzie starają się upraszczać wynalazki skomplikowane,  
bo prostota jest zawsze doskonała”*

*Alexandre Dumas*

*Skandynawski design, wydaje się idealnym odzwierciedleniem powyższych słów.*

*Ten wyjątkowy styl, sprawdza się zarówno w mieszkaniach w centrum miasta, jak i w domach położonych na peryferiach.*

*W skandynawskich wnętrzach dominują biel, prostota i poczucie świeżości.*

*Choć Skandynawia kojarzy się z zimą, to wnętrza są ciepłe, przytulne i sprawiają takie wrażenie nawet w najbardziej ponure jesienne i zimowe dni.*

*Bardzo charakterystycznym akcentem dla architektury skandynawskiej są wyszukane formy które urzekną każdego z nas. Stonowane barwy, naturalne tkaniny oraz drewno.*

*Pragniemy zaproponować Państwu oryginalne i wyjątkowe meble inspirowane naturą i jej prostotą. Tak by stały się ozdobą każdego wnętrza, a znakomita jakość i funkcjonalność była ich wizytówką.*

### **Kilka słów o Top-Line...**

*Produkujemy meble dla wymagających klientów z krajów skandynawskich już od 1986 roku. Ciągły rozwój przełożył się na obecność naszych produktów w wielu krajach Europy i Świata. Oferujemy unikalne, komfortowe meble wypoczynkowe wykonane z drewna oraz niepowtarzalnych na rynku polskim tkanin i skór.*

*Wyróżniamy się wyjątkowym wzornictwem i asortymentem, począwszy od brył klasycznych, przez nowoczesne designerskie, kończąc na meblach modułowych, które dają możliwość dowolnej aranżacji wnętrza.*

*Do produkcji naszych mebli wybieramy tylko najlepsze komponenty tworząc jakość na lata.*

**[www.nordicline.pl](http://www.nordicline.pl)**

## SPIS TREŚCI

|                               |                           |       |
|-------------------------------|---------------------------|-------|
| FUNKCJA SPANIA                | CLASSIC LIVING _____      | 4-6   |
| FUNKCJA SPANIA                | CLASSIC AMSTERDAM _____   | 7     |
| FUNKCJA SPANIA                | MIAMI _____               | 8     |
|                               | COUNTRY _____             | 9     |
|                               | ANGELICA _____            | 10-11 |
|                               | LUXEMBURG _____           | 12    |
| FUNKCJA SPANIA                | LINCOLN _____             | 13    |
|                               | CANELLA _____             | 14-15 |
|                               | BASIC _____               | 16    |
|                               | COMFORT 8000 _____        | 16    |
|                               | DELPHI _____              | 17    |
|                               | AURA _____                | 18    |
|                               | GIPSY _____               | 18    |
|                               | KINGSTON _____            | 19    |
|                               | MEMORY _____              | 20    |
|                               | RETRO _____               | 20    |
|                               | CHICO _____               | 21    |
|                               | VEGA _____                | 21    |
|                               | DIXIE _____               | 22    |
|                               | CIRCLE _____              | 22    |
|                               | DAYTONA _____             | 23    |
|                               | EASY&DIVA _____           | 23    |
|                               | ENJOY _____               | 24-25 |
|                               | MOLLY _____               | 25    |
|                               | FORLEE _____              | 26    |
| FUNKCJA SPANIA                | REMUS _____               | 27    |
|                               | DOMINO _____              | 27    |
| FUNCKJA SPANIA                | FUNKI _____               | 28    |
| FUNKCJA SPANIA                | FAKTA _____               | 29    |
| SYSTEM KRAK                   | WESTHAM _____             | 30    |
|                               | COZY _____                | 31    |
| FUNKCJA SPANIA                | TOKYO _____               | 32-33 |
| SYSTEM KRAK                   | ATLANTA _____             | 34-35 |
| SOFY MODUŁOWE, SYSTEM KRAK    | KIWI _____                | 36-37 |
| SOFY MODUŁOWE                 | VERONA _____              | 38-39 |
| SOFY MODUŁOWE, FUNKCJA SPANIA | PALERMO _____             | 40-43 |
|                               | MEDLEY _____              | 44    |
|                               | MARLIN _____              | 44    |
|                               | MONROE _____              | 45    |
|                               | NOVI CHAIR _____          | 45    |
|                               | BRISTOL _____             | 46    |
|                               | BRIDGE _____              | 46    |
|                               | GEORGE _____              | 46    |
|                               | LISA _____                | 47    |
| FUNKCJA RELAKS                | NINA _____                | 47    |
|                               | JEDO _____                | 47    |
| FUNKCJA RELAKS                | DIANA _____               | 48    |
| FUNKCJA RELAKS                | OLIVIA _____              | 48    |
|                               | CUBA _____                | 48    |
|                               | CHESS _____               | 48    |
|                               | VIENN _____               | 49    |
|                               | TULIP _____               | 49    |
|                               | LILJE _____               | 49    |
| FUNKCJA RELAKS                | WAVE _____                | 49    |
|                               | SKAMELE _____             | 50    |
|                               | DODATKI _____             | 51    |
|                               | SYSTEM KRAK _____         | 52    |
|                               | LEGENDA _____             | 53-54 |
|                               | TABELA INFORMACYJNA _____ | 55-59 |



**CLASSIC LIVING** 2 + 3 + BOK 02 + FOTEL LISA + PUF MINI 40

*(poduszki stałe, pokrowiec stały, falbana)*

*Cenisz elegancję i styl? Linia Classic zapewni Ci komfort i pełne odprężenie w luksusowych warunkach. Wybierz swój ulubiony wzór oparcia oraz wielkość sofy odpowiadającą Twoim wymaganiom. Linia Classic jest dostępna w szerokiej gamie wzorów, tkanin i skór naturalnych.*



**CLASSIC LIVING** CR 2/3 + BOK 01

*(poduszki stałe, pokrowiec stały)*



**CLASSIC LIVING 3 + 2 + BOK 01 + FOTEL BRISTOL + PUF BRISTOL**

*(poduszki stałe, pokrowiec stały, falbana)*



**CLASSIC LIVING 2 + 3 + BOK 02** *(poduszki stałe, pokrowiec stały)*



**CLASSIC LIVING CR 3/RX + BOK 02**  
*(poduszki stałe, pokrowiec stały)*



**CLASSIC LIVING 3 + 2 + BOK 01**  
*(poduszki stałe, pokrowiec stały, falbana)*



**CLASSIC LIVING 3 + CHG DIVAN + BOK 01**  
*(poduszki kopertowe, pokrowiec stały)*

## RODZAJE I WYMIARY BOKÓW



**BOK 01**  
szer. 30 cm wys. 68 cm



**BOK 02**  
szer. 24 cm wys. 63 cm



**BOK 03**  
szer. 27 cm wys. 61 cm



**BOK 04**  
szer. 12 cm wys. 60 cm



**BOK 05**  
szer. 23 cm wys. 62 cm



**BOK 06**  
szer. 27 cm wys. 61 cm

## WYMIARY PODANE BEZ BOKÓW

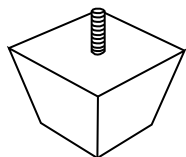

DREWNO

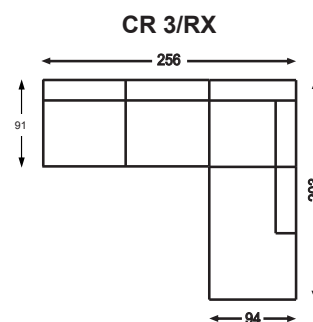
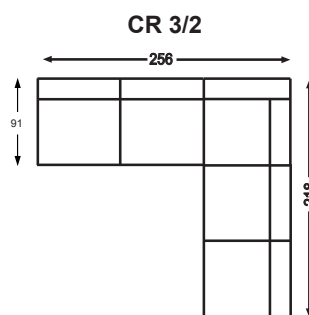
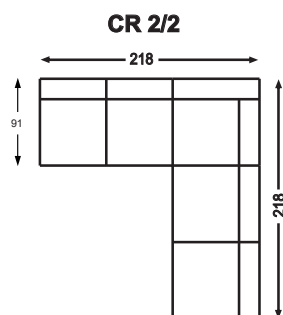
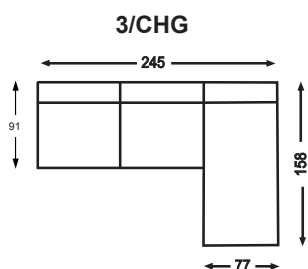
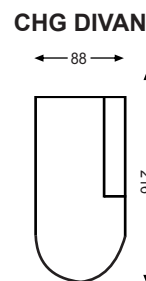
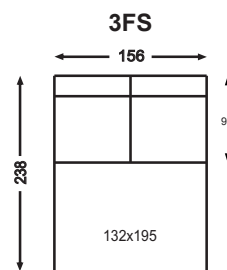
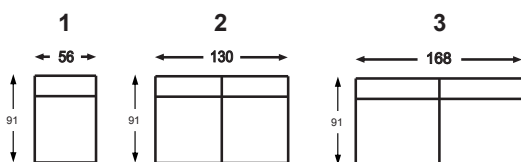

### ZANIM ZAMÓWISZ (wybrane opcje w cenie standardu)

1. Poduszki oparciowe wykonane z tkaniny (stałe lub kopertowe), obie wersje odwracalne
2. Standardowo stałe obicie. Możliwość wyboru pokrowca luźnego/zdejmowalnego (dostępny tylko do 1; 2; 3; 3FS i bokami od 01 do 05)
3. Standard bez falbany. Możliwość wykonania wszystkich brył z falbaną i z bokami od 01 do 06
4. CHG DIVAN – dostępny tylko z bokiem 01 lub 03 i poduszkami kopertowymi



GRUBOŚĆ MATERACA 12 cm



**CLASSIC AMSTERDAM 2+3**

(poduszki stałe, falbana)

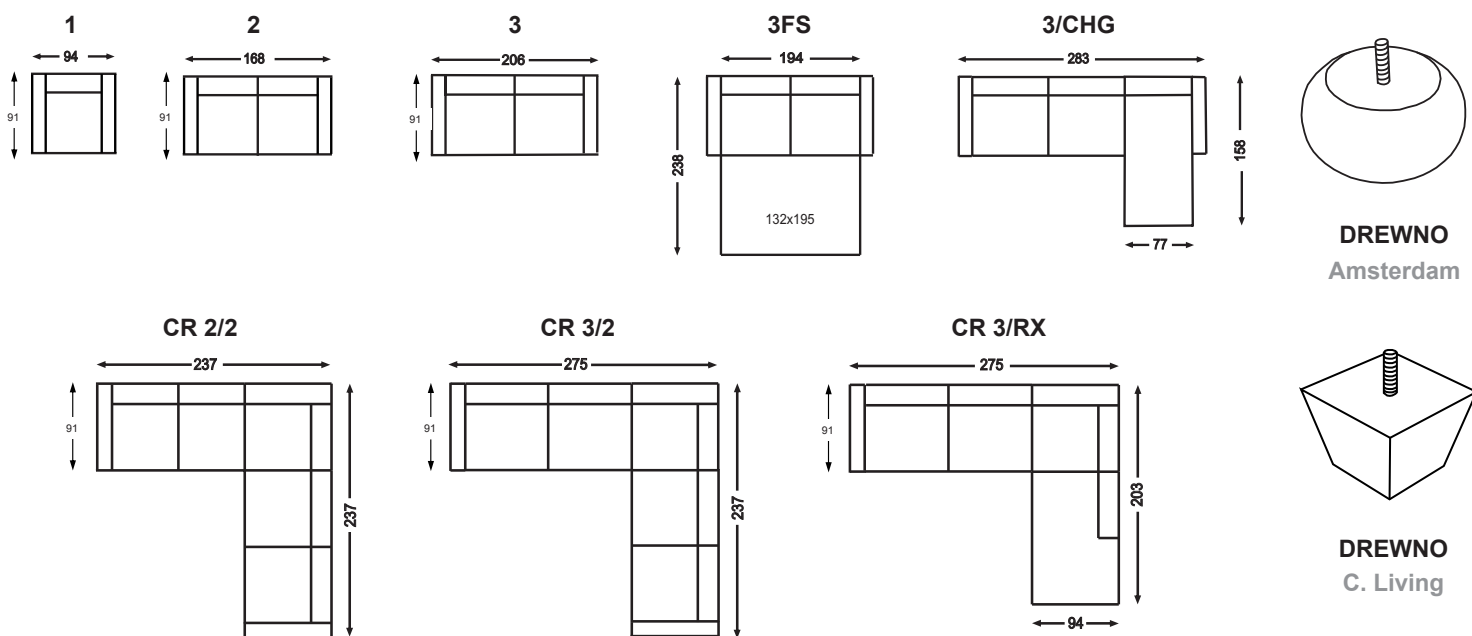

**CLASSIC AMSTERDAM CR 2/3**  
(3 z 3 poduszkami siedziskowymi i oparciowymi)

## ZANIM ZAMÓWISZ

(wybrane konfiguracje w cenie standardu)

1. Poduszki oparciowe wykonane z tkaniny (stałe lub kopertowe), obie wersje odwracalne
2. Standard bez falbany. Możliwość wykonania wszystkich brył z falbaną
3. Sofa 3, standard 2 poduszki siedziskowe i oparciowe, opcjonalnie może być wykonana z 3 poduszkami siedziskowymi i z 3 oparciowymi. Nie dotyczy sofy 3FS
4. Funkcja spania jak w Classic Living



**MIAMI** CR 2/2 + FOTEL BRISTOL + PUF BRISTOL

**Miami dostępne tylko z falbaną**

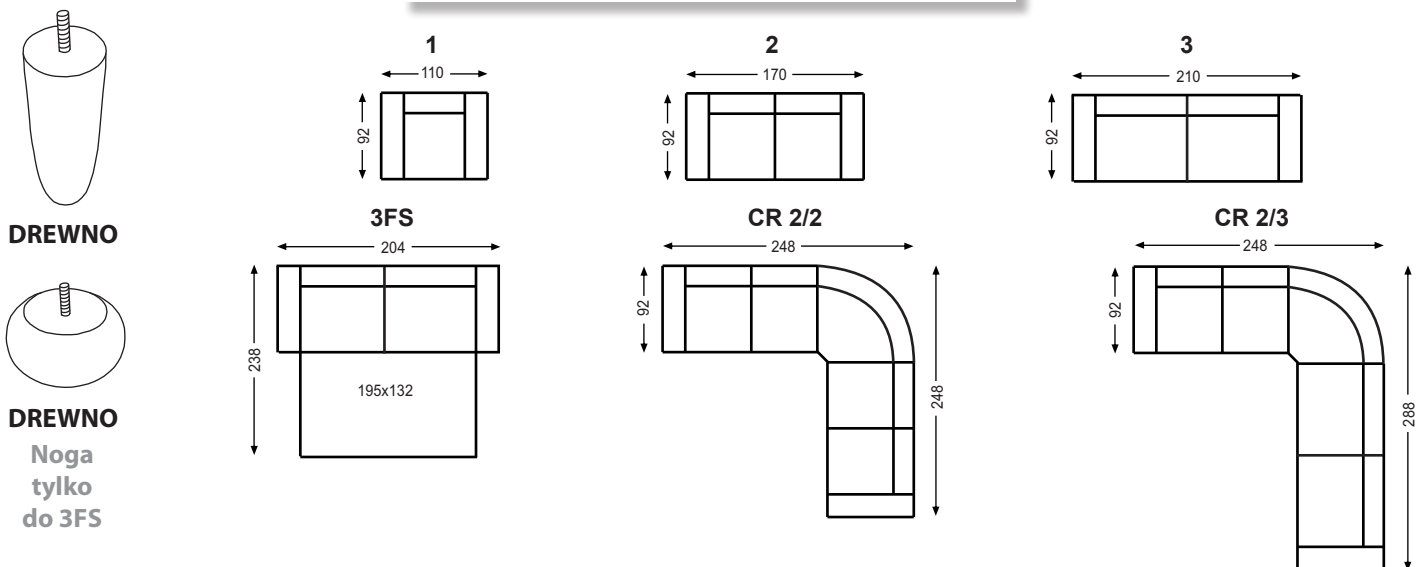

**MIAMI** 3 + 2 + FOTEL LISA + PUF MINI 40

**GRUBOŚĆ MATERACA 6 cm**





COUNRTY 3+2+FOTEL GEORGE

**Country dostępne tylko z poduszkami kopertowymi i bez falbany**

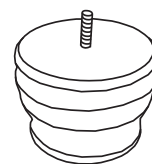
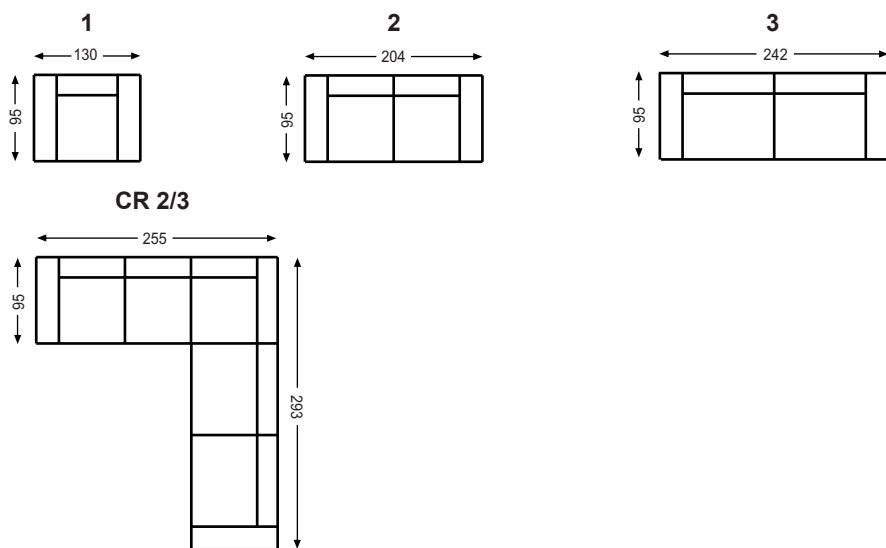

**DREWNO**  
Przód

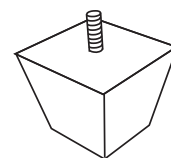

**DREWNO**  
Tył



COUNRTY 3



**ANGELICA** 2 + 3 + BOK 04



**ANGELICA** 2 + 3 + BOK 03

(nogi + rama)



**ANGELICA** CR 3/2 + BOK 04

(falbana)



**ANGELICA** 1 + 1 + 3 + BOK 02

(nogi + rama)

## RODZAJE BOKÓW



**BOK 01**



**BOK 02**



**BOK 03**



**BOK 04**



**BOK 05**

1. Standard bez falbany lub z falbaną. Falbana dostępna do wszystkich brył.
2. Standard noga bez ramy. Opcja noga + rama dodatkowo płatna, dostępna tylko do brył 1/2/3.

## WYMIARY PODANE Z BOKAMI

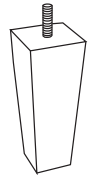
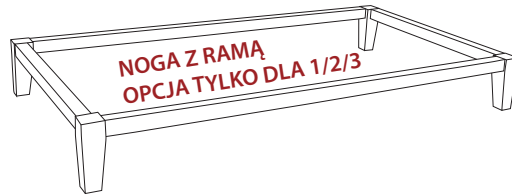

**DREWNO**

**BOK 01**

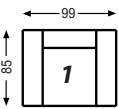

**BOK 02**

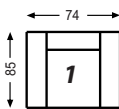

**BOK 03**

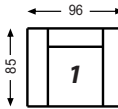

**BOK 04**

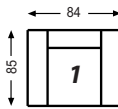

**BOK 05**

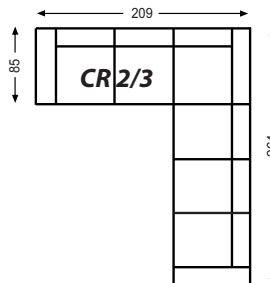
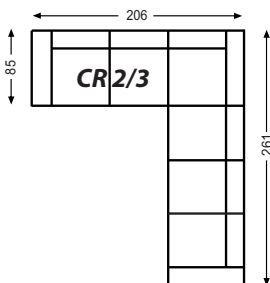
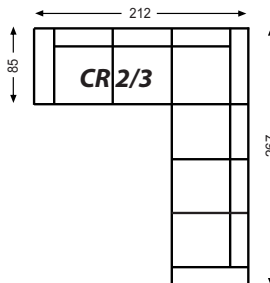
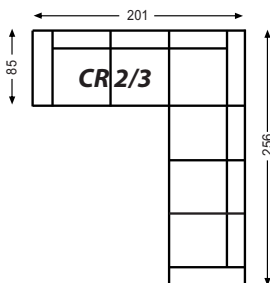
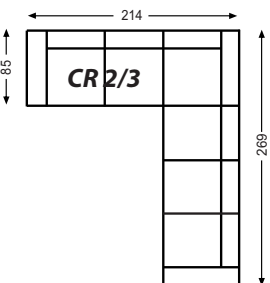
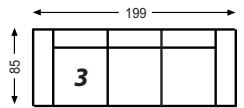
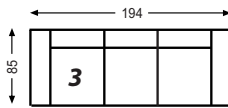
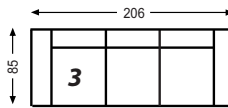
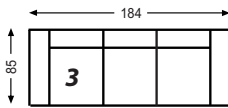
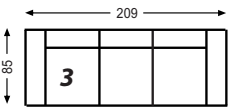
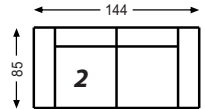
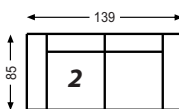
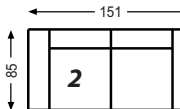
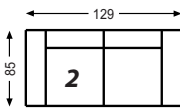
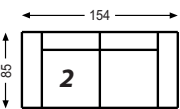
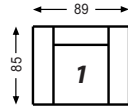



**LUXEMBURG 3 + 2**

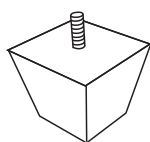

**DREWNO**

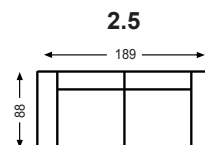
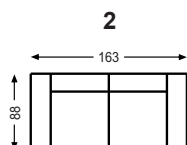
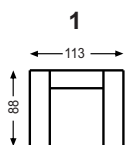

**3002-METAL REG.**

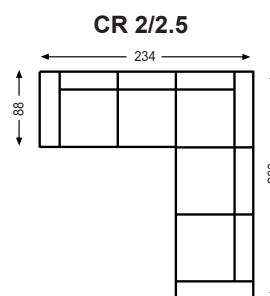
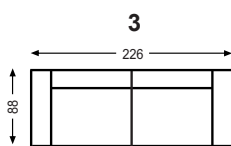

**LUXEMBURG CR 2/2.5 + FOTEL DIANA**



**LINCOLN 3+2**

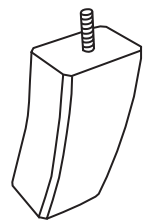
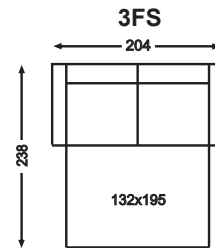
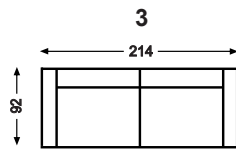
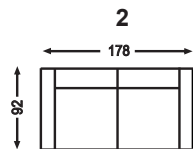
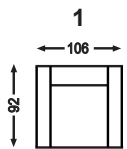

**DREWNO**



**GRUBOŚĆ MATERACA 12 cm**

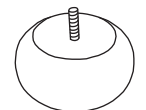
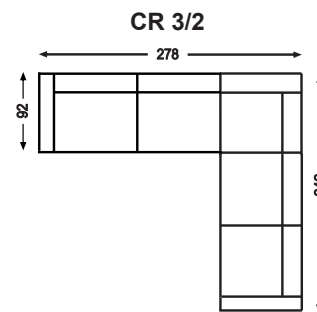
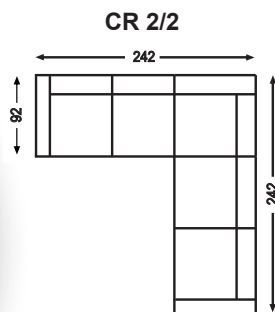

**DREWNO**

Noga  
tylko  
do 3FS



**LINCOLN 2+3**



**LINCOLN CR 2/3**



**CANELLA** CHG + 3 + PUF INDAGMA



**CANELLA** 3 + 1 BEZ BOKU + PUF INDAGMA



**CANELLA 2.5 + 3 + PUF INDAGMA**

**1 BEZ BOKU**

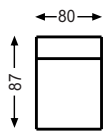

**1 Z BOKIEM**

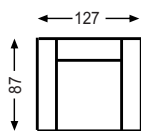

**CHG**

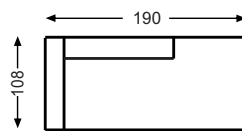

**2.5**

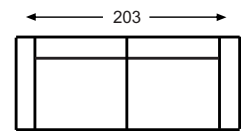

**3**

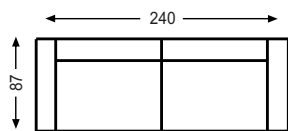

**CR 2.5/2.5**

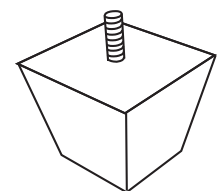
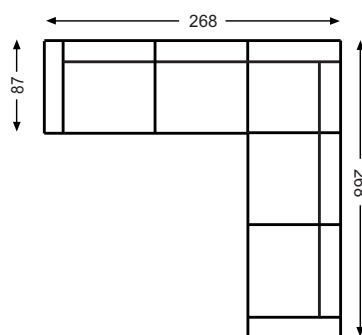

**DREWNO**



**CANELLA CR 2.5/2.5**



**CANELLA 2.5 + 3**



**BASIC 2.5**



**08/09 METAL**

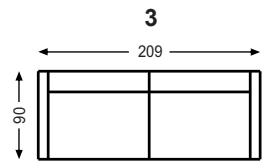
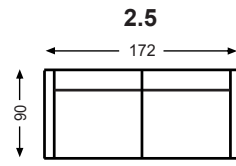
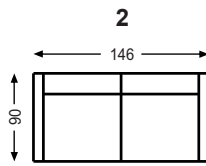
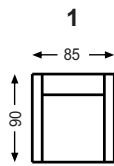

**COMFORT 8000 3 + FOTEL VERONA A BEZ BOKU + GLASS PUF 48**



**COMFORT 8000 2.5 + 3**



**MBR METAL**

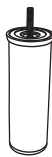

**METAL CHROM**

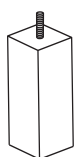

**DREWNO**

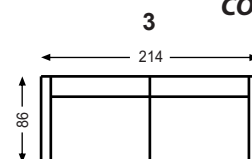
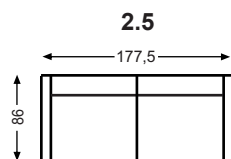





**DELPHI 3 + FOTEL LILJE**

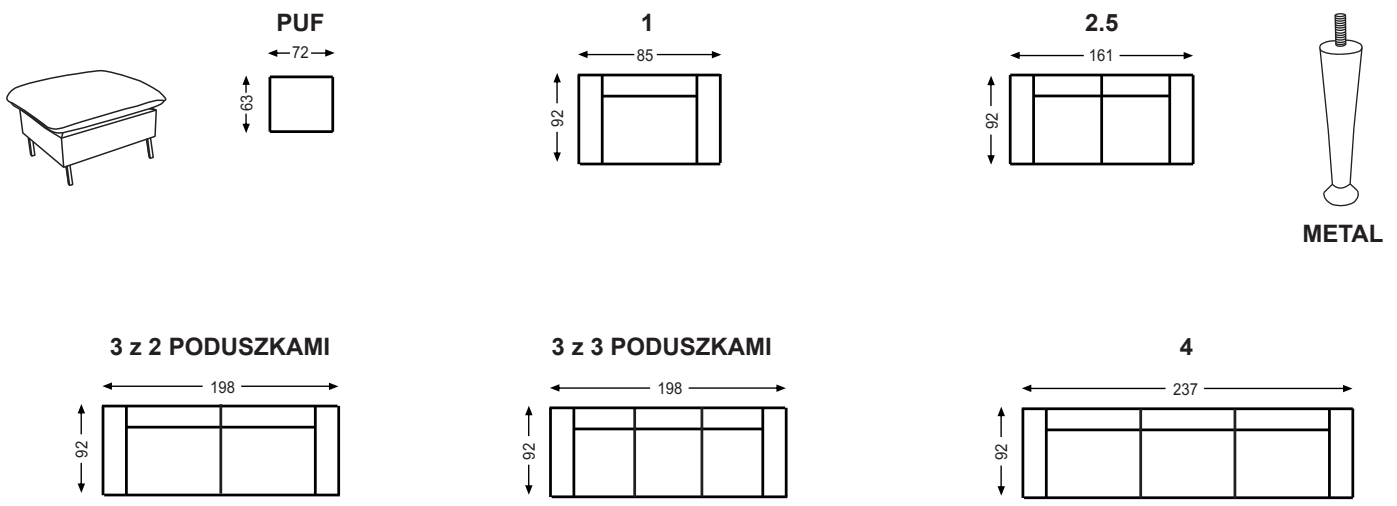

**DELPHI 3 z 3 poduszkami**



**DELPHI 3 + 2.5 + FOTEL OLIVIA + PUF OLIVIA**



**AURA** 3 + 2.5 + FOTEL TULIP



**07 - METAL**

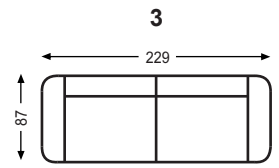
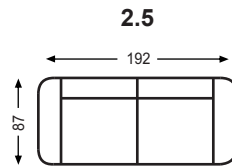
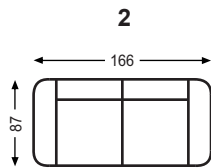
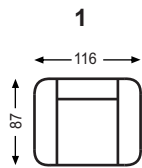

**GIPSY** 3



**PUF**

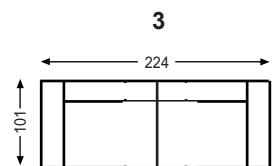
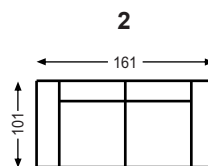
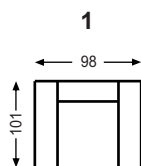
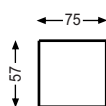

**DREWNO**  
Przód Tył



**KINGSTON 3+1+3**

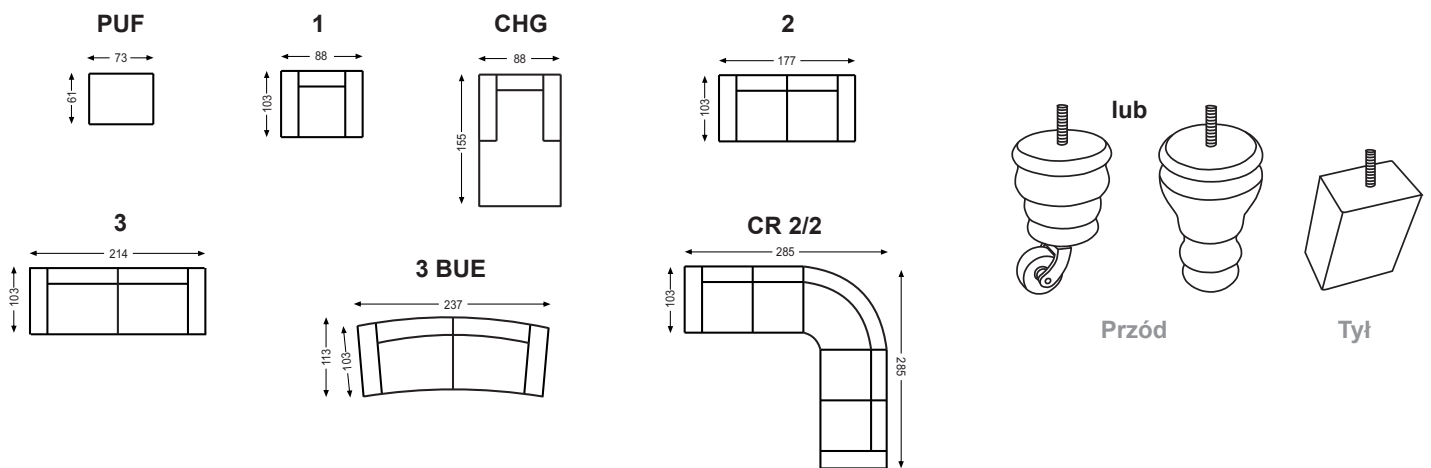

**KINGSTON 1 + PUF + 3**



**MEMORY 2 + 3**

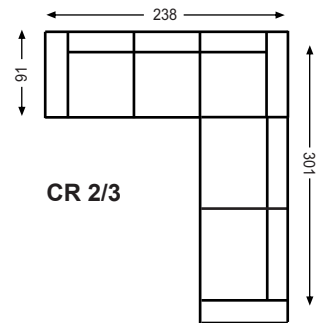
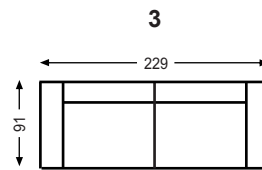
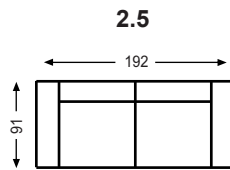
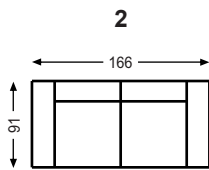

**DREWNO**



**RETRO 3 + FOTEL CHESS**

*(w sofie poduszki oparciowe pikowane z obu stron)*

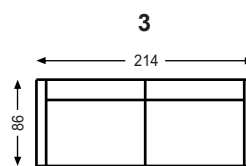
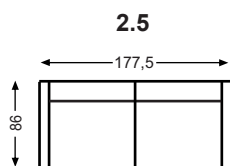



**CHICO** 1 + PUF + 3 + 2

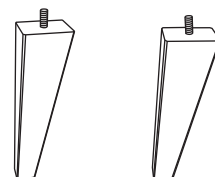
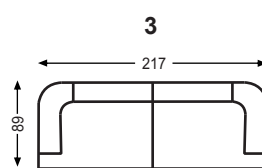
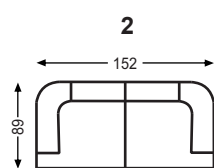
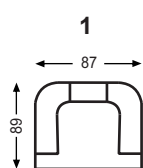
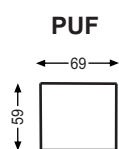

**DREWNO**  
Przód Tył



**VEGA** 3 + FOTEL DIXIE + GLASS PUF 48

(w sofie poduszki oparciowe pikowane z obu stron)

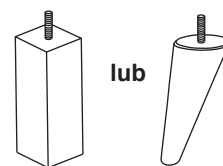
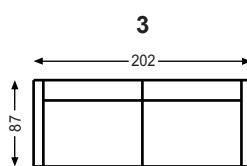
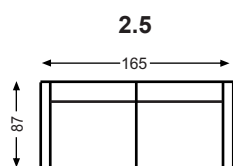

**DREWNO**  
SQUARE ROUND



**DIXIE 1 + PUF + 2 + 1**



**DIXIE 1**



**DIXIE 1 + CIRCLE**

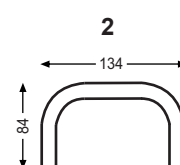
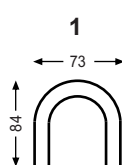
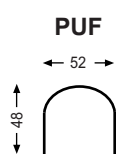
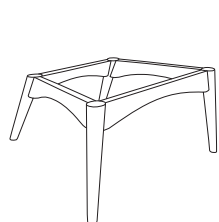

**CIRCLE 90**



**CIRCLE 50**



**DREWNO**

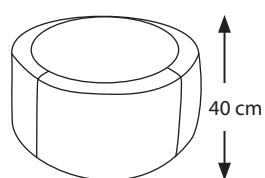

**Ø 50 / Ø 70 / Ø 90**

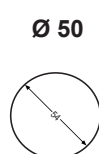

**Ø 50**

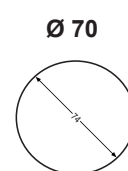

**Ø 70**

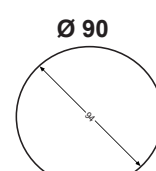

**Ø 90**

*Circle posiada otwierane wieko z możliwością obracania. Z jednej strony wykonane z obiciem: tkanina lub skóra, z drugiej strony dąb - dostępne w czterech kolorystykach. Puf z pojemnikiem.*



**DAYTONA 1 + 2.5 + FOTEL DIVA**

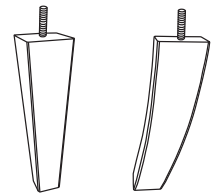
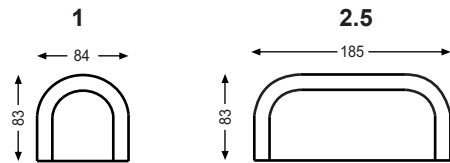

**DREWNO**  
Przód Tył

**EASY**

**DIVA**

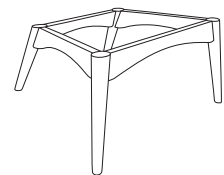
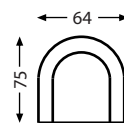
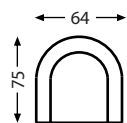
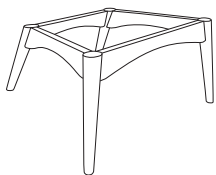



**ENJOY** 1+3+1+PUF

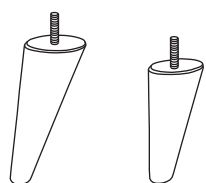

**DREWNO**

Przód

Tył

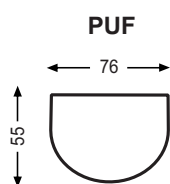

**PUF**

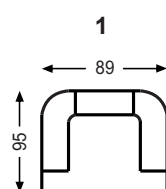

**1**

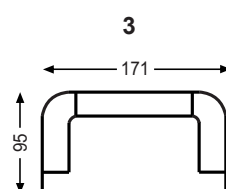

**3**



**ENJOY** 3+1+PUF





**ENJOY 3 + FOTEL MOLLY**

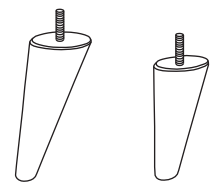
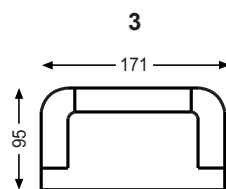
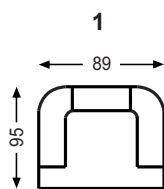
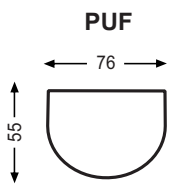

**DREWNO**  
Przód Tył



**MOLLY 1 + PUF + 3**

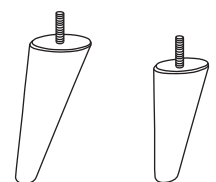
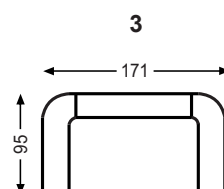
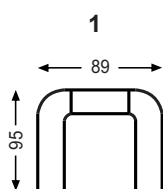
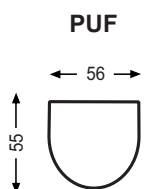

**DREWNO**  
Przód Tył



**FORLEE 3**

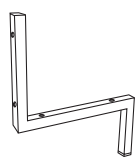
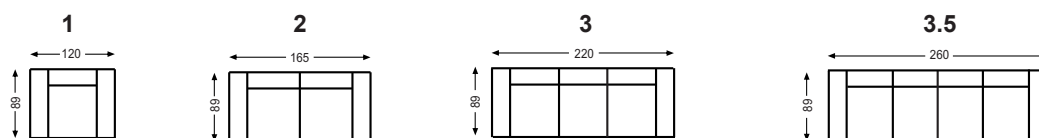

**METAL**

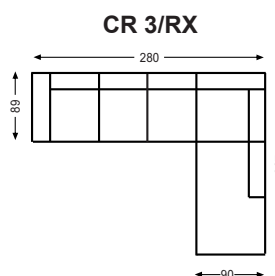
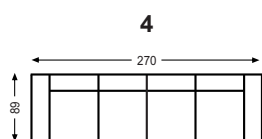

**FORLEE CR 3/RX**



**REMUS 3FS**

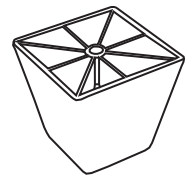
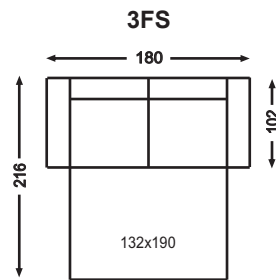

**PVC**



**DOMINO 2.5 + 2**

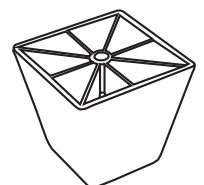
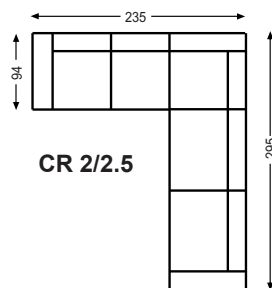
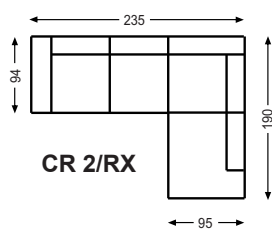
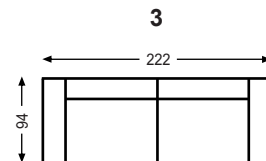
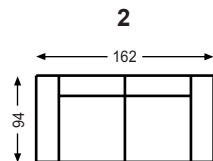
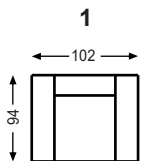

**PVC**



**FUNKI** 3FS/RX-BOX + GLASS PUF 48

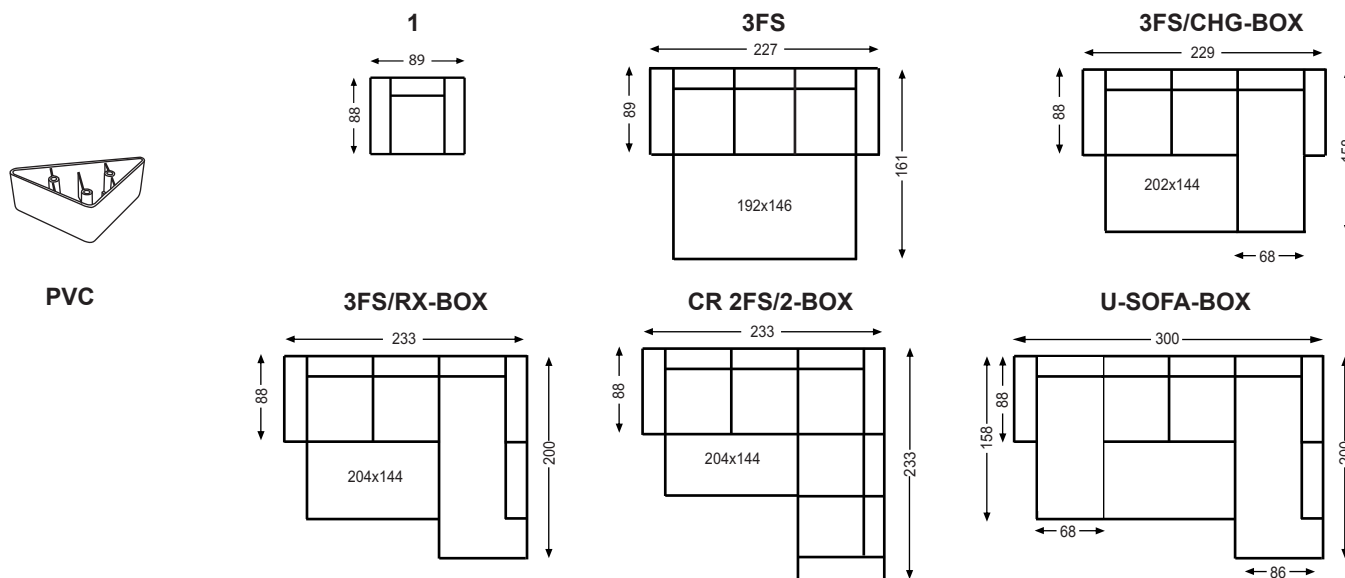

PVC



**FUNKI**  
3FS/CHG-BOX + GLASS PUF 48 (zagłówek X)



**FUNKI**  
3FS/RX-BOX



**FUNKI**  
3FS/CHG-BOX + GLASS PUF 48 (zagłówek X)



**FUNKI**  
U-SOFA (CHG-BOX/2FS/RX-BOX)



**FUNKI**  
U-SOFA (CHG-BOX/2FS/RX-BOX)  
+ GLASS PUF 48 (zagłówek X)



**FUNKI**  
U-SOFA (CHG-BOX/2FS/RX-BOX)



**FAKTA 3FS/CHG-BOX**

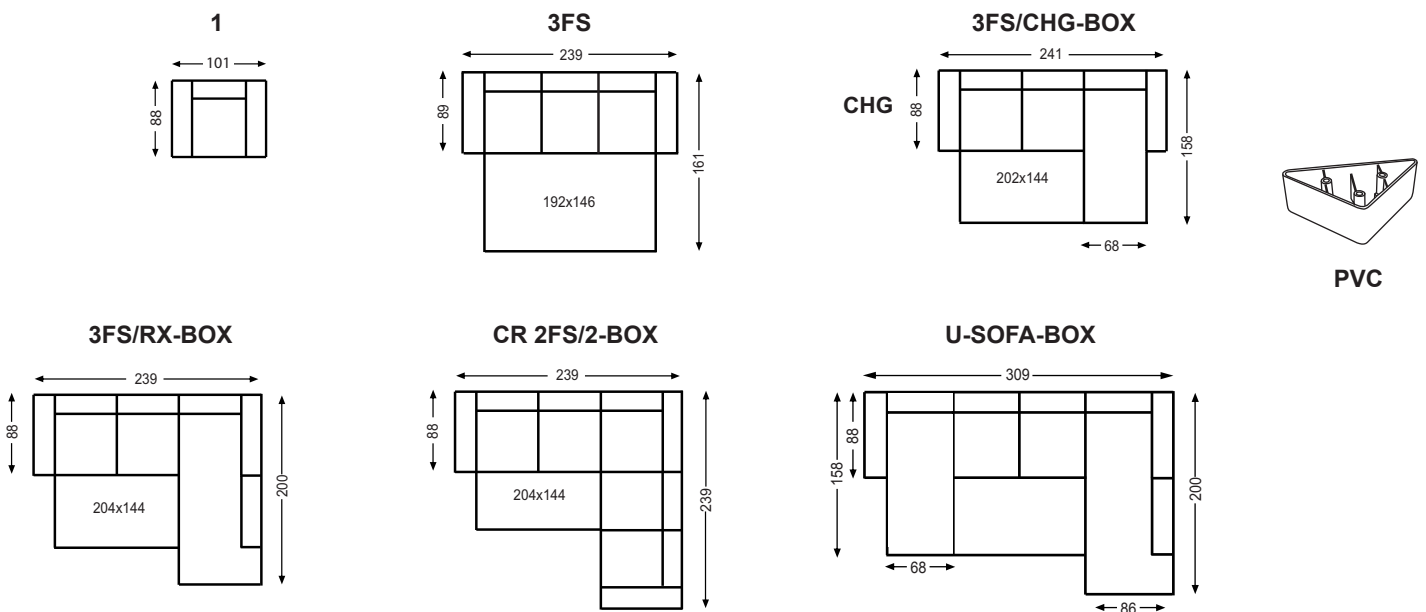

*W kolekcjach FUNKI i FAKTA grubość materaca w funkcji spania - 10 cm*



**FAKTA 3FS/CHG-BOX**



**FAKTA 3FS/CHG-BOX**



**WESTHAM 2+3 XL**

*System KRAK zastosowany w sofie 3 XL. Szczegółowe informacje o systemie na stronie 52*

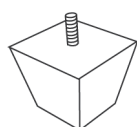
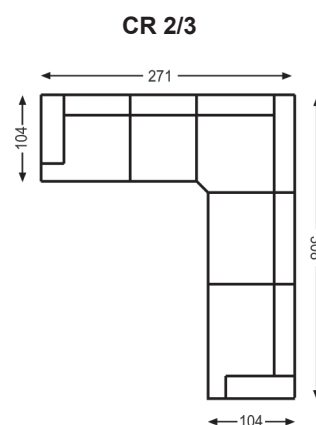
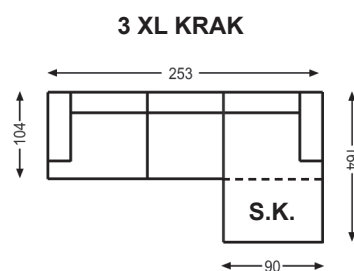
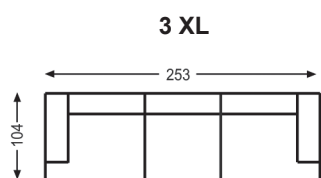
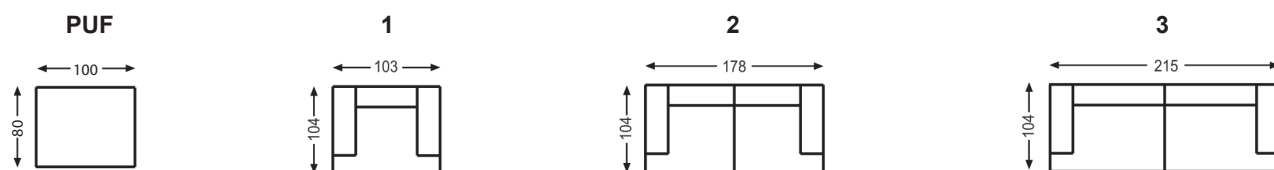

**DREWNO**



**COZY** CR 3/RX + FOTEL LILJE

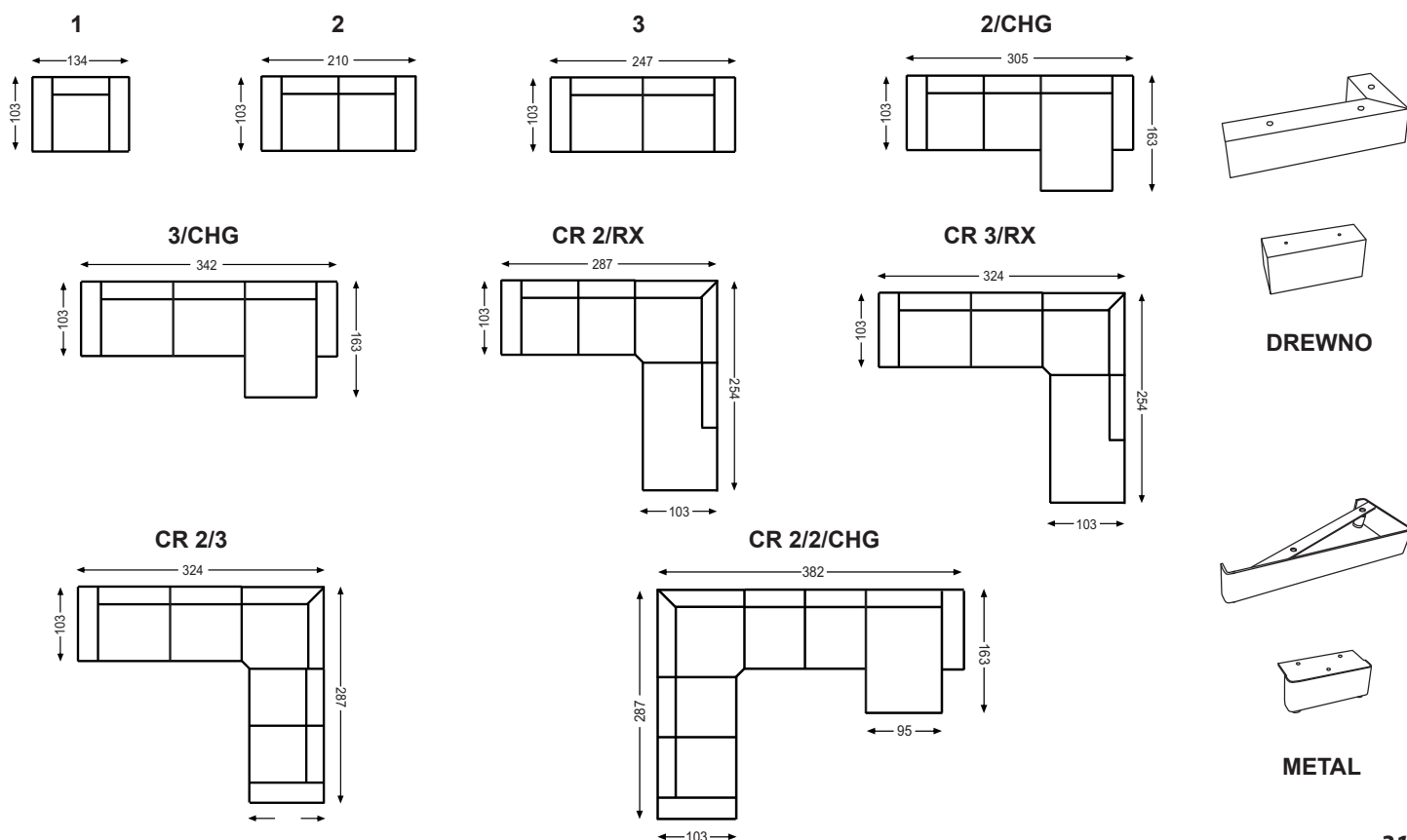



**TOKYO CR 2.5FS/RX + BOK C**



**TOKYO CR2/2.5 + BOK C (zagłówek X3, roletka drewniana)**



**TOKYO 3FS + BOK B**

*(zagłówek X3)*



**TOKYO 2.5FS/CHG + BOK A**

*(wypełnienie DUN-TOP siedzisko i oparcie)*



# RODZAJE I WYMIARY BOKÓW

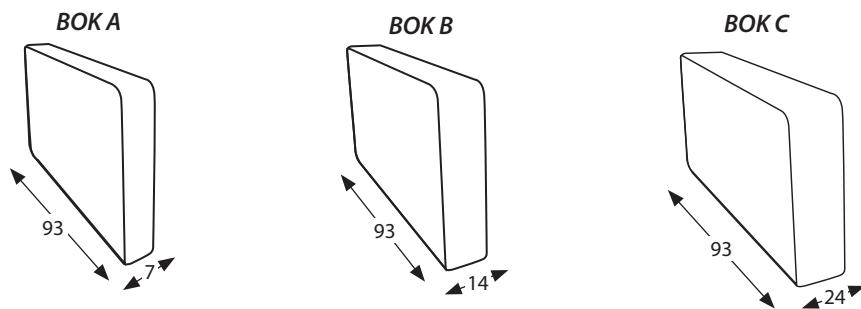

## WYMIARY PODANE BEZ BOKÓW

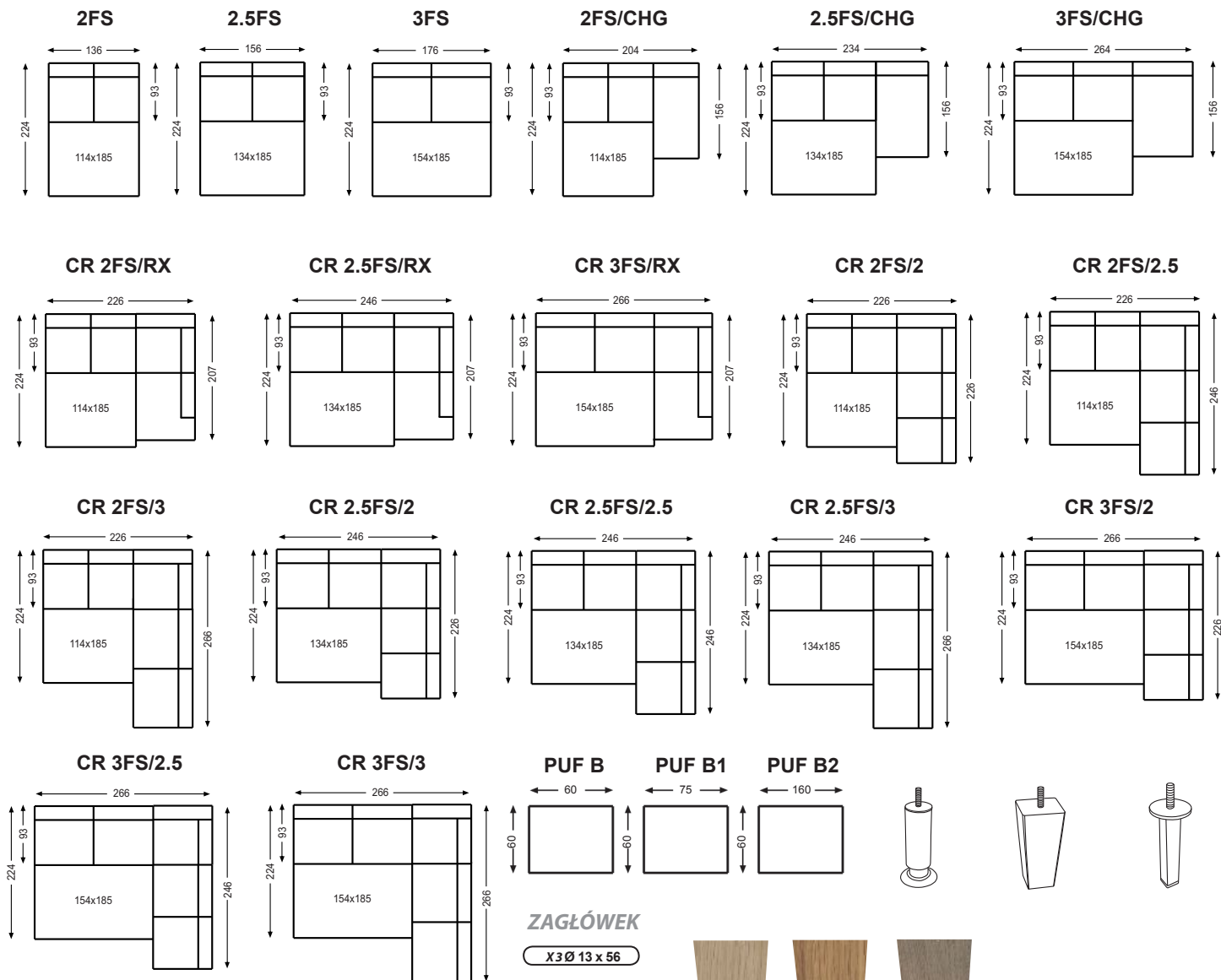

### ZAGŁÓWEK

X 3 Ø 13 x 56



TOKYO 3FS + BOK B GRUBOŚĆ MATERACA 7.5 cm



**ATLANTA 5 + BOK 01**

*(zagłówek X gazetnik)*



**ATLANTA 1 + BOK 01**  
*(zagłówek X, roletka drewniana)*



**ATLANTA 6 + BOK 01**



**ATLANTA 2 + BOK 01** *(zagłówek X)*



**ATLANTA 3 + BOK 01 + GLASS PUF**  
*(zagłówek X, gazetnik, roletka drewniana)*



**ATLANTA 2 + BOK 01 + GLASS PUF 48**  
*(zagłówek X, gazetnik)*



**ATLANTA 4 + BOK 01**  
*(zagłówek X)*

## RODZAJE I WYMIARY BOKÓW



**BOK 01** ←28→



**BOK 02** ←21→

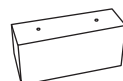

**Noga BOK 01**  
Standard: dębowa lub metal-aluminium

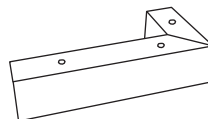

**Noga BOK 02**  
Standard: dębowa lub metal-aluminium

## WYMIARY POADANE Z BOKIEM 01

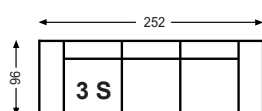
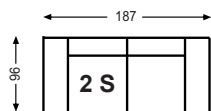
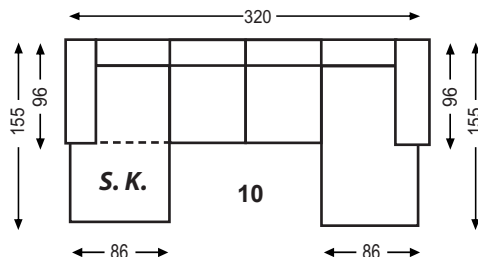
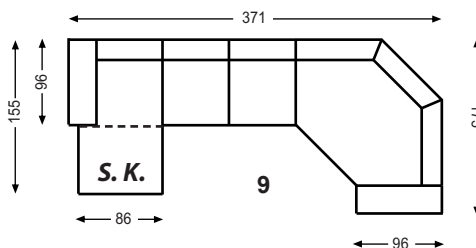
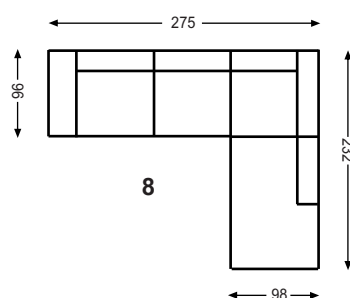
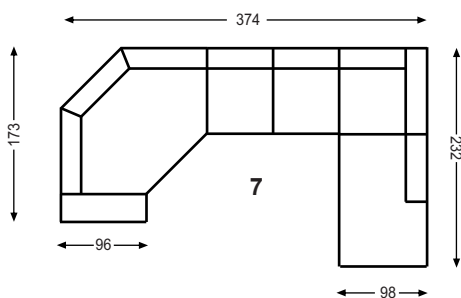
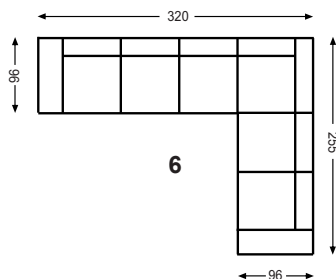
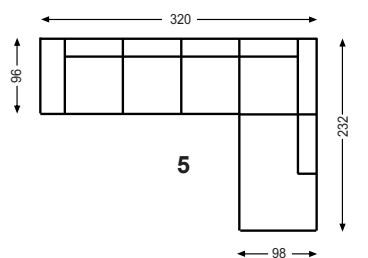
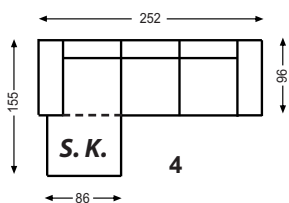
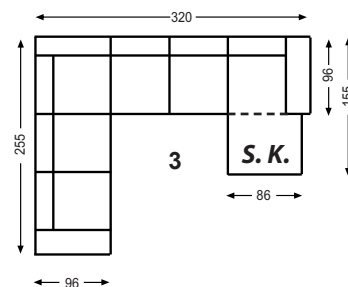
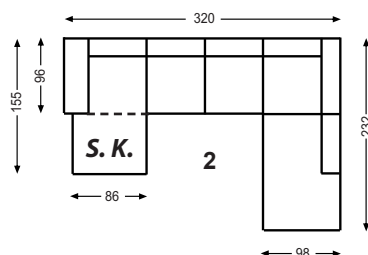
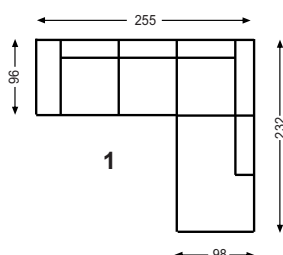

System KRAK zastosowany w: 2, 3, 4, 9, 10. Szczegółowe informacje o systemie na stronie 52

# Projektuj w 3D Studio

szczegóły na stronie www



KIWI E2-P-D-O-E2

(zagłówek X)



KIWI E1-P2-D-F1 + GLASS PUF 48

(zagłówek X)



KIWI E3-P2-E3

(zagłówek X)



KIWI 2 (E4-O-E4) +3 (E4-P-E4)

# Zaprojektuj swoją sofę

Sofy modułowe, dzięki możliwości nieograniczonego zestawiania poszczególnych elementów, pozwalają na uzyskanie mebli odpowiadających dokładnie Twoim oczekiwaniom.

## RODZAJE I WYMIARY BOKÓW

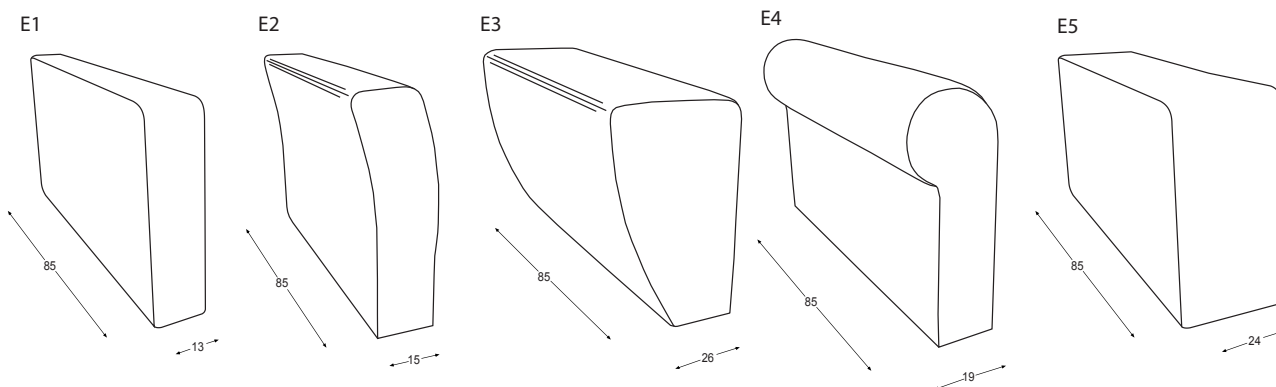

System KRAK zastosowany w modułach: O2, P2, N2. Szczegółowe informacje o systemie na stronie 52

## SOFY

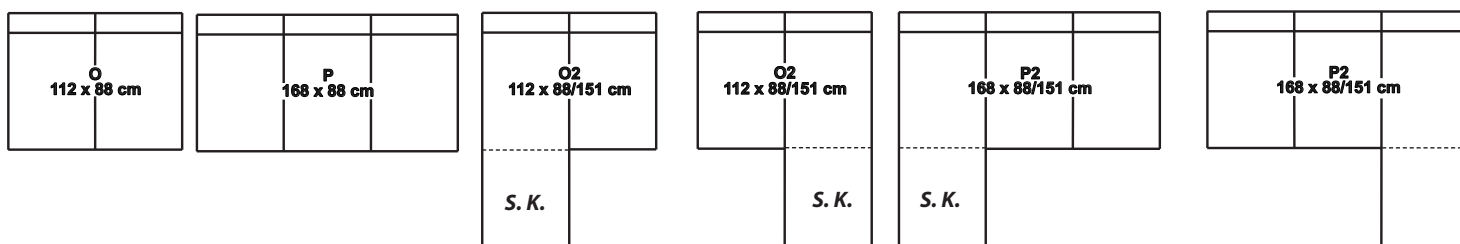

## FOTELE

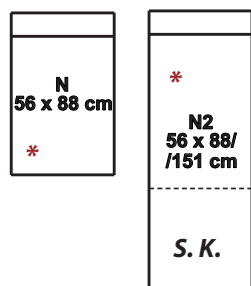

## CZĘŚĆ NAROŻNA

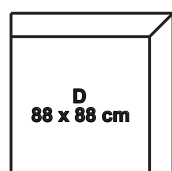

## ZAKOŃCZENIA

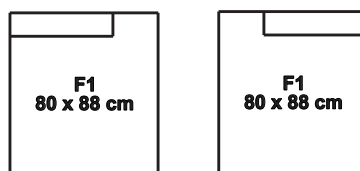

## PUF

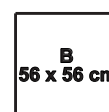

## ZAGŁÓWEK

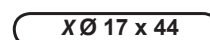

\* Moduł N i N2 można również wykorzystać jako element przy tworzeniu kompozycji takich, jak sofy/narożniki

## RODZAJE NÓG



10 - METAL  
REG.



81 - Dqb  
czarny  
olejowany  
O02



83 - Buk  
lakierowany  
B11



84 - Buk  
surowy  
B00



90 - Dqb  
olejowany  
D13



91 - Dqb  
surowy  
D00



92 - Dqb  
szary  
olejowany  
D01



93 - Dqb  
smoked  
olejowany  
D04



94 - Dqb  
biały  
olejowany  
D03





**VERONA F1-D-F-E + FOTEL A BEZ BOKU**

*(zagłówek X, gazetnik, wypełnienie DUN-TOP siedzisko i oparcie)*



**VERONA E-F-D-F1 + PUF B**

*(zagłówek X)*



**VERONA M-N-C-O-D-O-M**

*(zagłówek X)*



**VERONA I-T-P-I**

*(wypełnienie DUN-TOP siedzisko i oparcie)*

## RODZAJE I WYMIARY BOKÓW

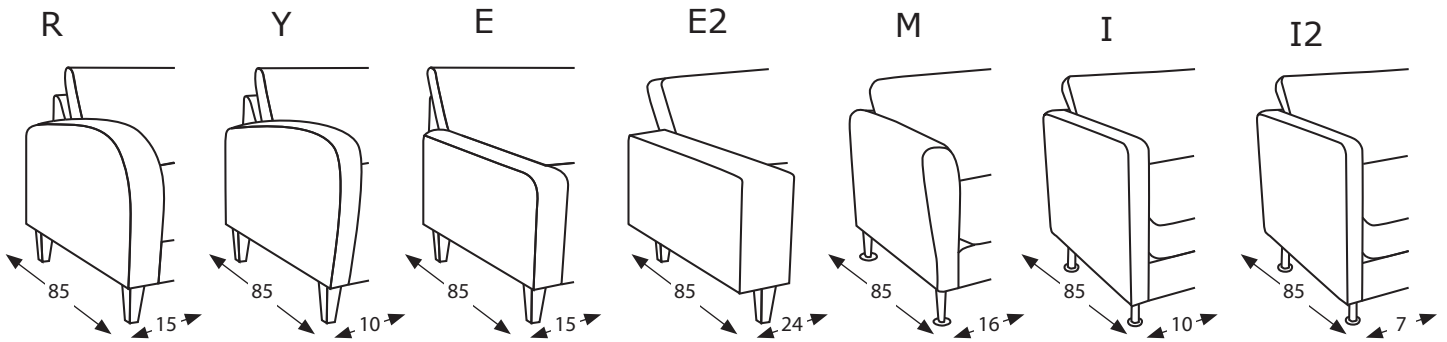

Każdy z boków dedykowanych do Verony w standardzie posiada poduszkę boczną.

R: Ø 60 cm, Y: Ø 60 cm, E: 55 x 50 cm, E: 55 x 50 cm, M: Ø 14 x 50 cm, I: Ø 14 x 50 cm, I2: Ø 14 x 50 cm

### SOFY



### CZĘŚĆ NAROŻNA

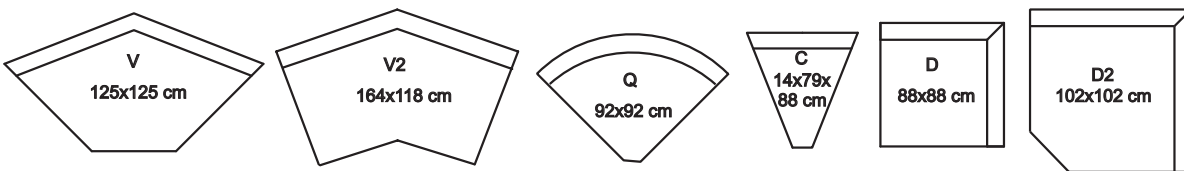

### ZAKOŃCZENIA

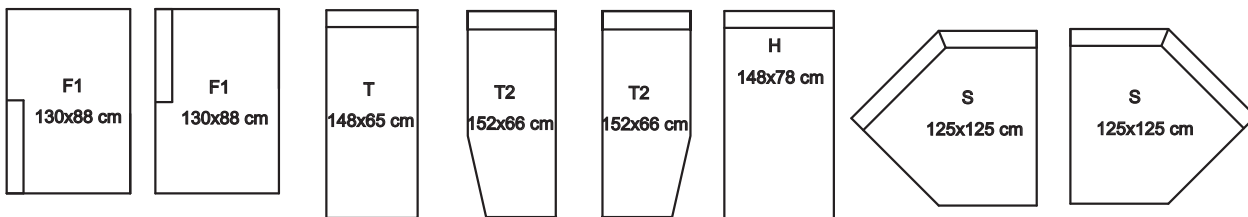

### PUF



### ZAGŁÓWKI

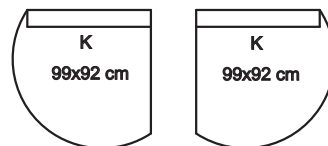
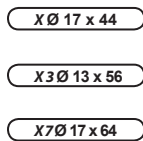

\* Moduł N i A można również wykorzystać jako element przy tworzeniu kompozycji takich, jak sofy/narożniki

## RODZAJE NÓG





**PALERMO J-O-D2-F-H-J3**

*(zagłówek X)*



**PALERMO Y-O-D-F5-Y + GLASS PUF 48**

*(zagłówek X)*





**PALERMO J-O-K + PUF L**



**PALERMO J-O-D-F-H-J3 (zagłówek X, roletka drewniana)**    **PALERMO J3-T-T-J3 (DUN-TOP siedzisko i oparcie)**



**PALERMO O-D2-F-T-J (podłokietnik X6, zagłówek X)**



**PALERMO I-F5-D-O-I**



**PALERMO I-F5-D-O-I**

GRUBOŚĆ MATERACA 6 cm



**PALERMO Y-O-Q-A-K+L**

## RODZAJE NÓG

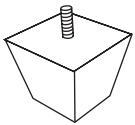

25 - Buk lakierowany B11



26 - Buk surowy B00



28 - Dąb olejowany D13



29 - Dąb surowy D00



30 - Dąb czarny olejowany O02



31 - PVC chromowane



32 - 3002 - METAL REG.



33 - Dąb szary olejowany D01



34 - Dąb smoked olejowany D04



35 - Dąb biały olejowany D03

## RODZAJE I WYMIARY BOKÓW

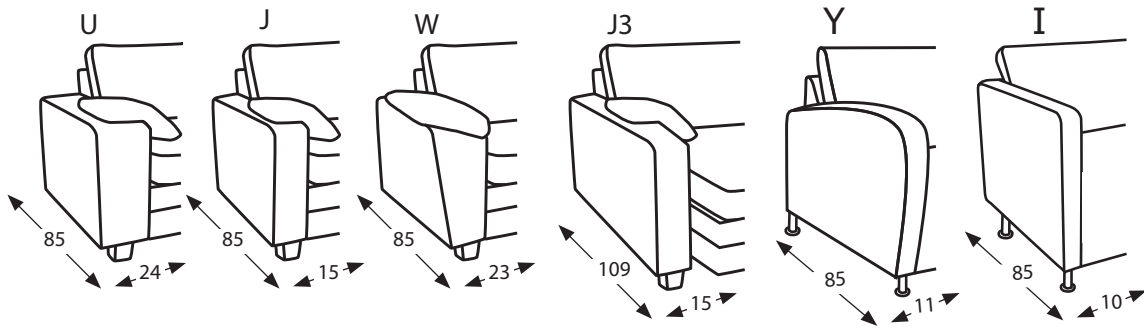

Do modułu „H3” pasuje tylko bok „U”  
 Bok „J3” dedykowany do modułów „H” i „T”  
 Do boków „Y” i „I” pasuje tylko noga „32”

**Każdy z boków dedykowanych do Palermo w standardzie posiada poduszkę boczną.**

U: 55x50 cm, J: 55x50 cm, J3: 55x50 cm, W: „gunn”, Y: Ø60 cm, I: Ø14x50 cm.

### SOFY

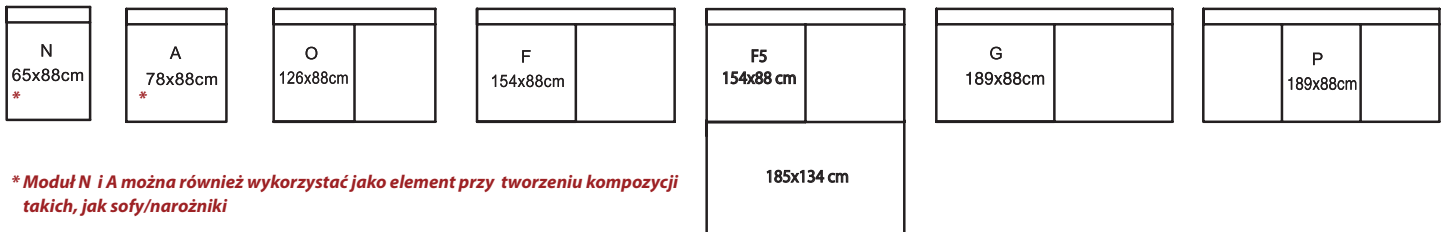

\* Moduł N i A można również wykorzystać jako element przy tworzeniu kompozycji takich, jak sofy/narożniki

### CZĘŚĆ NAROŻNA

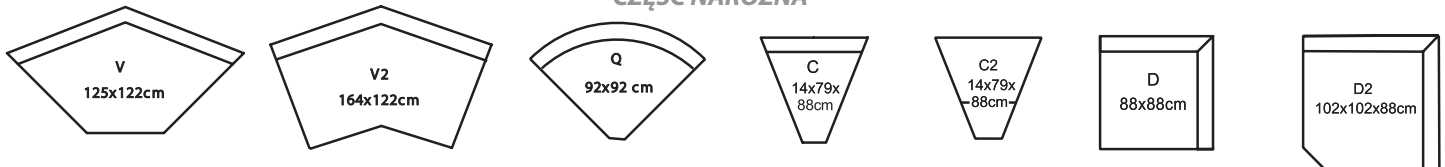

### ZAKOŃCZENIA

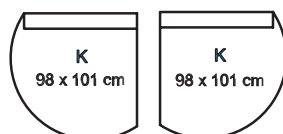
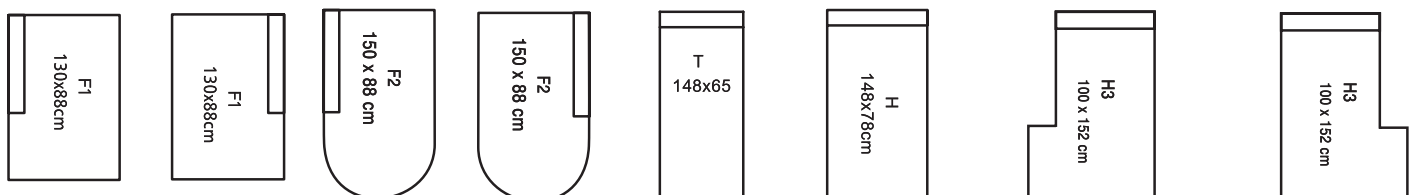

### PUF



### ZAGŁÓWKI

- X Ø 17 x 44
- X 3 Ø 13 x 56
- X 7 Ø 17 x 64
- X 6 38 x 17 x 15



**MEDLEY 1 + 1 + 1.5 + 2.5**

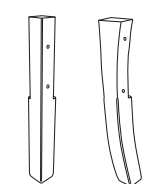

Przód Tył

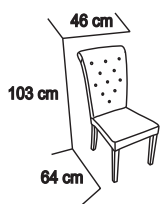

**KRZESŁO**

**KRZESŁO**

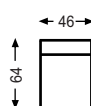

**1.5**

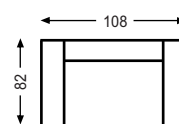

**2.5**

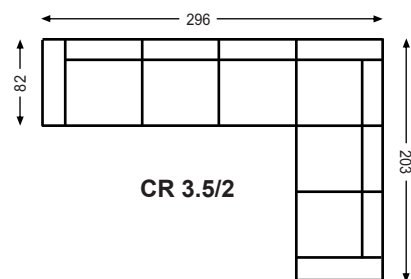
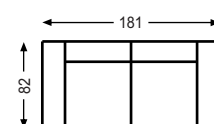

**CR 3.5/2**

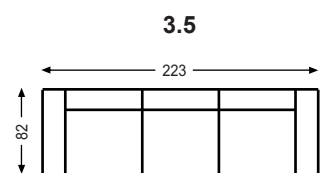

**3.5**

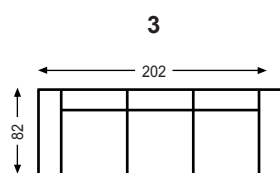

**3**



**MARLIN 3 + KRZESŁO NOVI CHAIR**

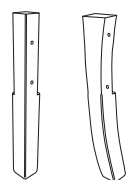

Przód Tył

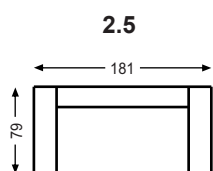

**2.5**

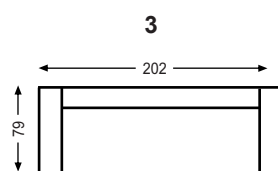

**3**



**MONROE CR 3.5/2 + BOK 01 + 1**

## RODZAJE BOKÓW



**BOK 01**



**BOK 02**



**BOK 03**



**BOK 04**



**BOK 05**

### NOGI BOK 02-05

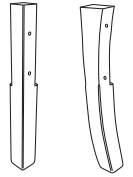

Przód Tył

### NOGI BOK 01

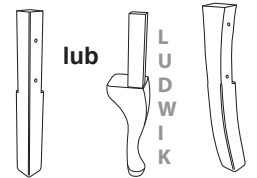

lub

L  
U  
D  
W  
I  
K

Przód Tył

### WYMIARY PODANE Z BOKIEM 01

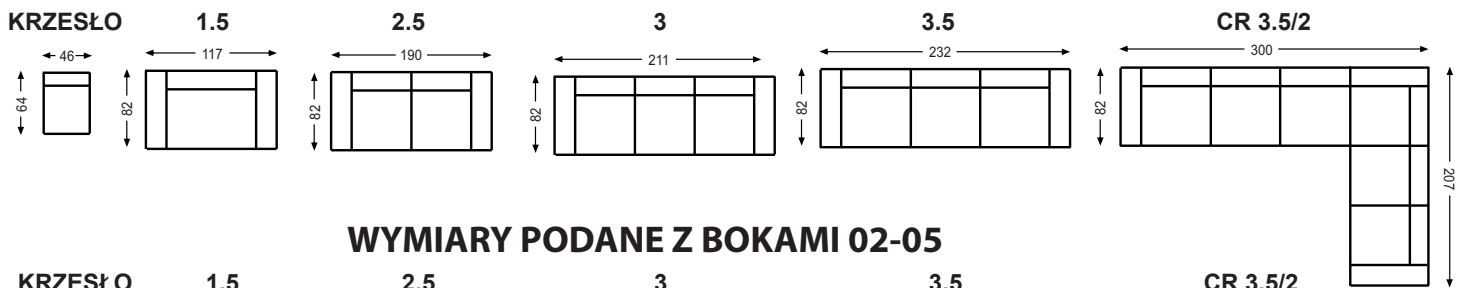

### WYMIARY PODANE Z BOKAMI 02-05

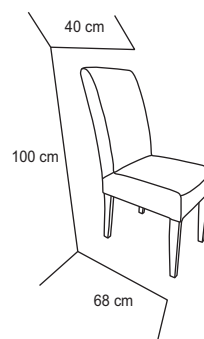
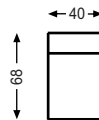
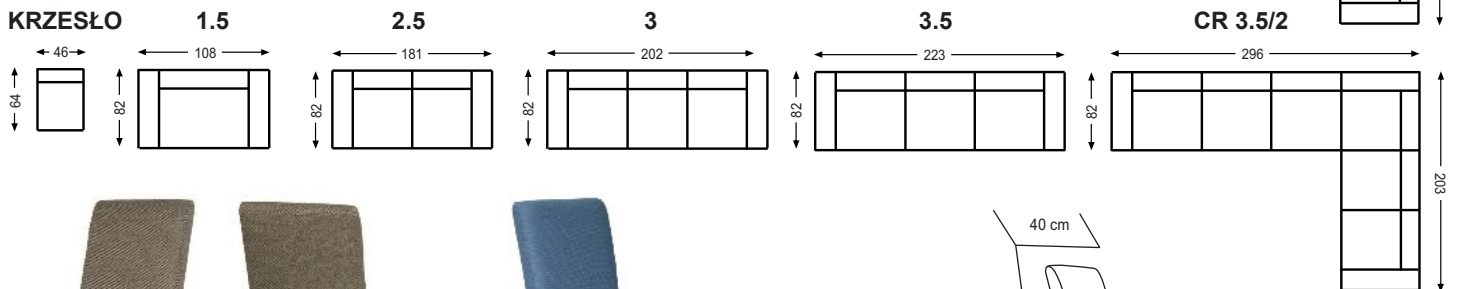

**NOVI CHAIR**



Przód

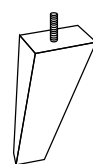

Tył

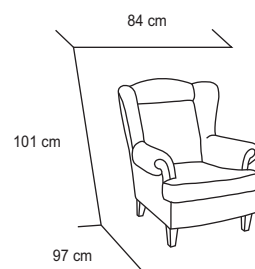
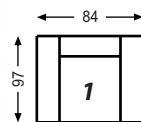

**FOTEL BRISTOL + PUF BRISTOL**  
Fotel/puf standard bez lub z falbaną  
Puf z pojemnikiem

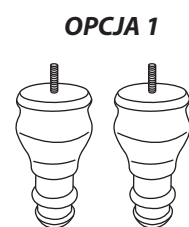

Przód Tył

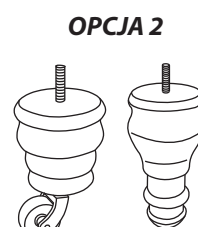

Przód Tył

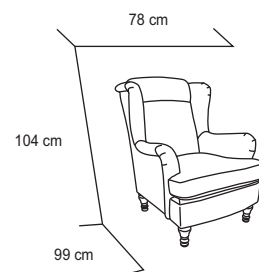
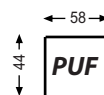
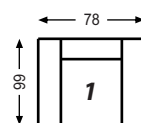

**FOTEL BRIDGE + PUF BRIDGE**

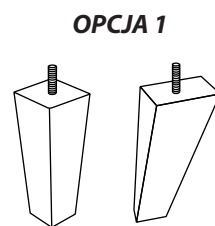

Przód Tył

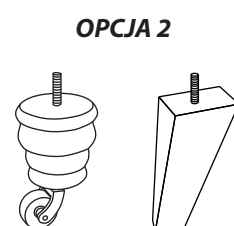

Przód Tył

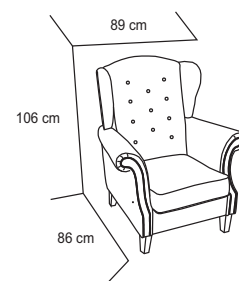
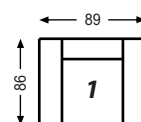

**FOTEL GEORGE**  
Standard bez ćwieków na frontach boków lub z ćwiekami



**FOTEL LISA**  
Standard bez lub z falbaną

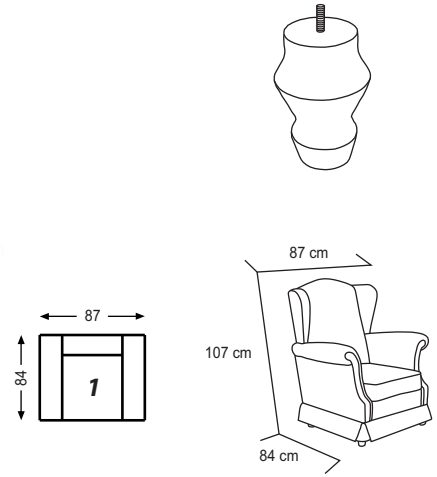

**FOTEL NINA**  
POSIADA FUNKCJĘ RELAKS  
Standard bez lub z falbaną

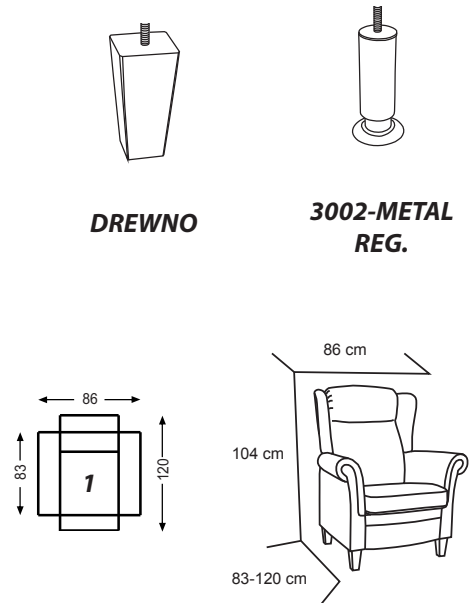

**FOTEL JEDO**

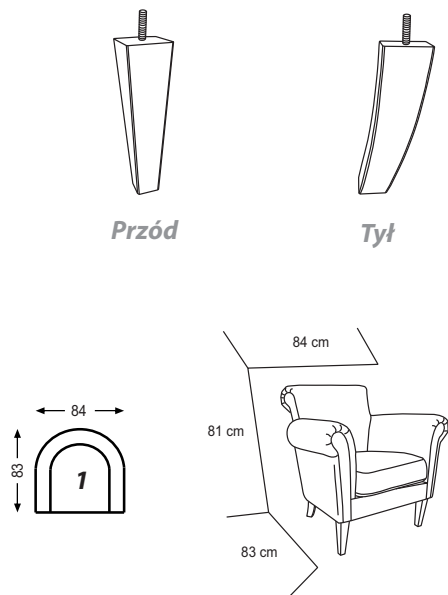



**FOTEL DIANA**  
 POSIADA FUNKCJĘ RELAKS  
 Standard bez lub z falbaną



**DREWNO**



**3002-METAL  
 REG.**

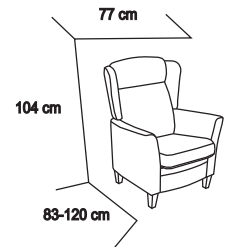
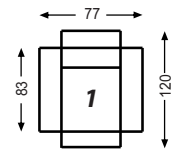

**FOTEL OLIVIA + PUF OLIVIA**  
 POSIADA FUNKCJĘ RELAKS  
 Puf z pojemnikiem

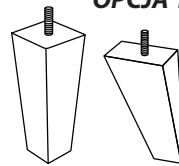

**Przód**

**Tył**

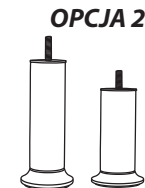

**10-METAL REG.  
 Przód Tył**

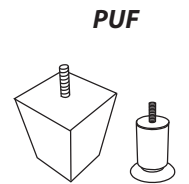

**OPCJA 1 OPCJA 2**

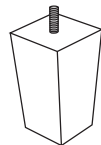
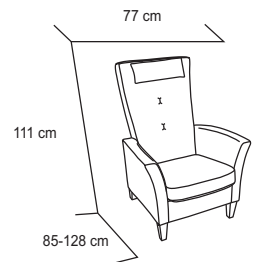
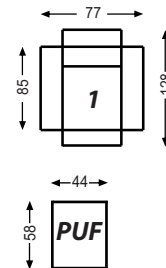

**Przód**

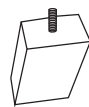

**Tył**

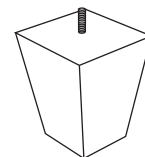

**Przód**



**Tył**



**FOTEL CUBA**

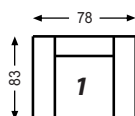
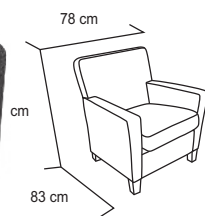

**FOTEL CHESS**

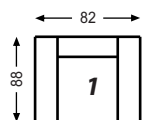
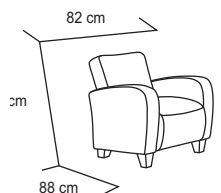



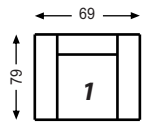

**Z BOKIEM**

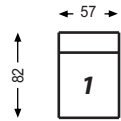
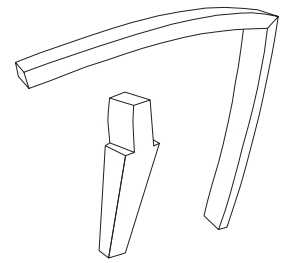

**BEZ BOKU**

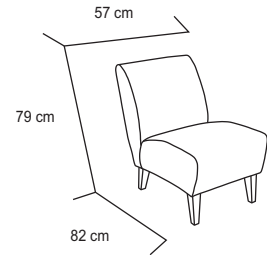

**FOTEL VIENN**  
Standard z bokiem lub bez boku

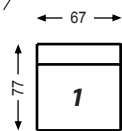
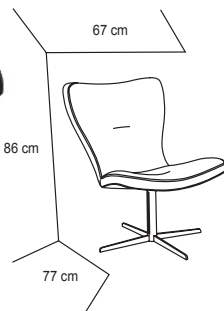
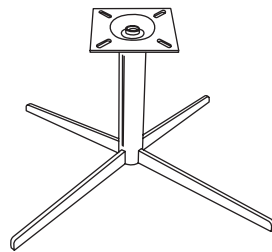

**FOTEL TULIP**

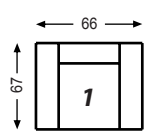
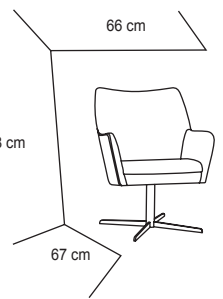
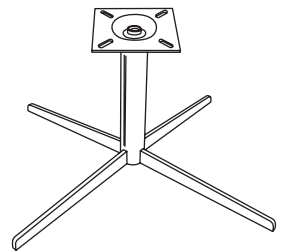

**FOTEL LILJE**

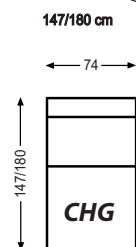
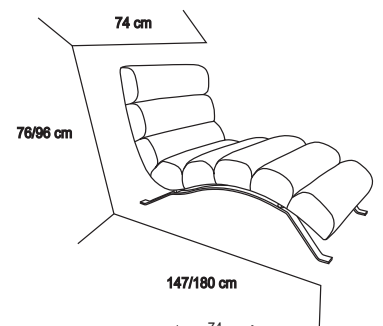
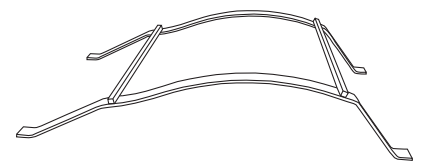

**CHG WAVE**  
POSIADA FUNKCJĘ RELAKS

# SKAMELE



**MINI 40**  
Puf z pojemnikiem

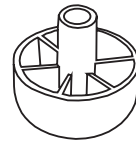
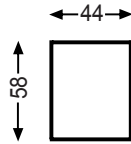

PVC



**MIDI 80**  
Puf z pojemnikiem

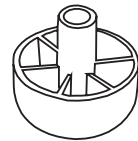
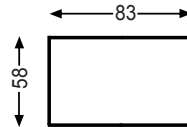

PVC



**GULL PUF 48**

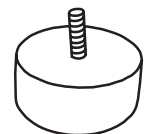
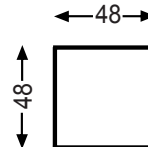

DREWNO



**GLASS PUF 48**  
Wyciągana szyba

**GLASS PUF 48**

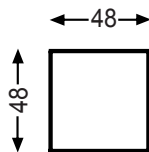

**GLASS PUF 80**

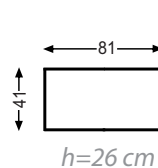

**GLASS PUF 80 W**

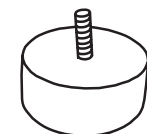
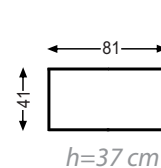

DREWNO

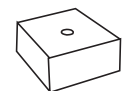

DREWNO  
80 i 80 W



**INDAGMA**

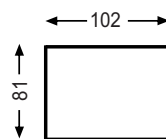

PUF

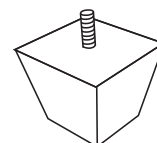

DREWNO

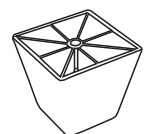

PVC

# DODATKI

## PODUSZKI DEKORACYJNE 45x45



## PODUSZKI DEKORACYJNE K1 i K2



**K2**  
70x40 cm



**K1**  
60x50 cm

## ZAGŁÓWKI



**X**  
ø 17x44 cm



**X3**  
ø 13x56 cm



**X7**  
ø 17x64 cm



**X6**  
38x17x15 cm

*Zaglówek X pasuje do modeli: Palermo, Verona, Kiwi, Atlanta, Fakta, Funki, Basic, Aura, Comfort 8000, Vega*

*Zaglówek X3 pasuje do modeli: Palermo, Verona, Tokyo*

*Zaglówek X7 pasuje do modeli: Palermo, Verona*

*Podłokietnik X6 pasuje do wszystkich modeli, w których poduszki siedziskowe są obracalne. Infomacja str. 55-59*

## PODUSZKA BOCZNA Z



ø 14x50 cm

## PODUSZKA BOCZNA 55 x 50



55x50 cm

## GAZETNIK



*Gazetnik posiada dwie kieszenie, może być wykonany z tkaniny lub skóry  
Gazetnik nie jest przymocowany na stałe do boku*

## ROLETKA NA BOK



*Roletka wykonana z drewna dębowego w kolorach:*  
• dąb surowy D00  
• dąb olejowany D13  
• dąb czarny olejowany O02  
• dąb biały olejowany D03

# SYSTEM KRAK

SYSTEM KRAK ZASTOSOWANY W MODELACH: ATLANTA, KIWI, WESTHAM  
DZIĘKI RUCHOMEMU ELEMENTOWI, POZWALA NA SZYBKĄ REKOMPOZYCJĘ  
SOFY/NAROŻNIKA WEDŁUG POTRZEB

SYSTEM PREZENTUJEMY PONIŻEJ NA PRZYKŁADZIE MODELU ATLANTA 03

*Wystarczy wyciągnąć poduszkę siedziskową,  
pod którą znajdują się puf...*



ETAP 1



ETAP 2



ETAP 3



ETAP 4



*Puf posiada metalowy zaczep, dzięki czemu szybko i bez problemów możemy go zamocować do ramy w sofie*

**SYSTEM KRAK DOSTĘPNY TYLKO W SOFACH/NAROŻNIKACH WYKONANYCH Z TAKNINY**

# LEGENDA

## OPIS OZNACZEŃ UŻYTYCH W KATALOGU

|             |   |                         |
|-------------|---|-------------------------|
| <b>PUF</b>  | – | puf                     |
| <b>1</b>    | – | fotel                   |
| <b>2</b>    | – | sofa 2 osobowa          |
| <b>2.5</b>  | – | sofa 2.5 osobowa        |
| <b>3</b>    | – | sofa 3 osobowa          |
| <b>3.5</b>  | – | sofa 3.5 osobowa        |
| <b>4</b>    | – | sofa 4 osobowa          |
| <b>CHG</b>  | – | chaiselong              |
| <b>RX</b>   | – | relax                   |
| <b>CR</b>   | – | narożnik                |
| <b>FS</b>   | – | funkcja spania          |
| <b>BOX</b>  | – | pojemnik na pościel     |
| <b>S.K.</b> | – | system KRAK             |
| <b>BUE</b>  | – | „Łuk” mebel profilowany |

---

*Konfigurację mebla zawsze czytamy od lewej strony stojąc przodem do sofy*

---

*Możliwość wykonania w układzie prawo/lewo wszystkich sof z CHG lub RX, i wszystkich CR znajdujących się w katalogu*

---

*W kolekcjach Diana, Kiwi, Luxemburg, Nina, Olivia, Palermo, Tokyo, Verona stosowane są nogi metalowe z możliwością regulacji wysokości, nogi te (przy każdym z wymienionych wyżej modeli) zostały wyróżnione symbolami:*

**3002 METAL REG.** – regulacja wysokości max 2 cm

**10 METAL REG.** – regulacja, wysokości max 2 cm

## WYBARWIENIA NÓŻEK DREWNIANYCH



## WYPEŁNIENIA

*W siedziskach i oparciach stosujemy pianki wysokoelastyczne oraz różnego rodzaju wypełnienia, dzięki którym uzyskujemy bardzo duży komfort użytkowania*

- I – Pianka wysokoelastyczna
- II – MIX: 70% frytka lateksowa + 30% kulka silikonowa
- III – MIX: kulka silikonowa + pierze + frytka z pianki
- IV – DUN-TOP ( pianka wysokoelastyczna ubrana w pokrowiec wypełniony mixem pierza i frytki )
- V – Granulat z pianki
- VI – MIX: granulat z pianki + kulka silikonowa
- VII – Kulka silikonowa

Opis oznaczeń wypełnień - użytych w tabeli



| MODEL          | UKŁAD                    | WYPEŁNIENIE SIEDZISZA /OPARCE       | DOSTĘPNE NOGI /KOLORYZACJE                         | DOSTĘPNE TAPICERKI | PODUSZKI SIEDZISKOWE I OPARCOWE OBRACALNE TYLKO WTKANINIE SIEDZISKOWE/OPARCE | PODUSZKA DEKORACYJNA /BOCZNA W STANDARDZIE | DODATKOWE INFORMACJE                |
|----------------|--------------------------|-------------------------------------|--|--------------------|--|--|-------------------------------------|
| CLASSIC LIVING | 1                        | Tkanina I/II; Skóra I/II            | D00, D03, D01, D04, O02, D13                       | Tkanina / Skóra    | Tak / Tak  | Brak / Brak                                | DUN-TOP siedzisko / oparcie (Opcja) |
|                | 2                        | Tkanina I/II; Skóra I/II            | D00, D03, D01, D04, O02, D13                       | Tkanina / Skóra    | Tak / Tak  | 2x 50x50 cm / Bak                          | DUN-TOP siedzisko / oparcie (Opcja) |
|                | 3                        | Tkanina I/II; Skóra I/II            | D00, D03, D01, D04, O02, D13                       | Tkanina / Skóra    | Tak / Tak  | 2x 50x50 cm / Bak                          | DUN-TOP siedzisko / oparcie (Opcja) |
|                | 3F5                      | Tkanina I/II; Skóra I/II            | D00, D03, D01, D04, O02, D13                       | Tkanina / Skóra    | Tak / Tak  | 2x 50x50 cm / Bak                          | DUN-TOP siedzisko / oparcie (Opcja) |
|                | CHG DIVAN                | Tkanina I/II; Skóra -/-             | D00, D03, D01, D04, O02, D13                       | Tkanina            | Nie / Tak  | 3x 50x50 cm / Brak                         | DUN-TOP siedzisko / oparcie (Opcja) |
|                | 3/CHG                    | Tkanina I/II; Skóra I/II            | D00, D03, D01, D04, O02, D13                       | Tkanina / Skóra    | Tak / Tak  | 3x 50x50 cm / Brak                         | DUN-TOP siedzisko / oparcie (Opcja) |
|                | CR 2/2                   | Tkanina I/II; Skóra I/II            | D00, D03, D01, D04, O02, D13                       | Tkanina / Skóra    | Tak / Tak  | 3x 50x50 cm / Brak                         | DUN-TOP siedzisko / oparcie (Opcja) |
|                | CR 3/RX                  | Tkanina I/II; Skóra -/-             | D00, D03, D01, D04, O02, D13                       | Tkanina            | Tak / Tak  | 3x 50x50 cm / Brak                         | DUN-TOP siedzisko / oparcie (Opcja) |
|                | CR 3/2                   | Tkanina I/II; Skóra I/II            | D00, D03, D01, D04, O02, D13                       | Tkanina / Skóra    | Tak / Tak  | 3x 50x50 cm / Brak                         | DUN-TOP siedzisko / oparcie (Opcja) |
|                | 2.5                      | Tkanina I/IV; Skóra I/IV            | MBR METAL SZCZOTKOWANY, METAL CHROM, B00, D00, O02 | Tkanina / Skóra    | Tak / Tak  | -  | Zaglówek X (Opcja)                  |
| COMFORT 8000   | 3                        | Tkanina I/IV; Skóra I/IV            | MBR METAL SZCZOTKOWANY, METAL CHROM, B00, D00, O02 | Tkanina / Skóra    | Tak / Tak  | -  | Zaglówek X (Opcja)                  |
|                | 1                        | Tkanina I/II; Skóra -/-             | O02  | Tkanina            | Tak / Tak  | 2x 50x50 cm / Brak                         | -                                   |
|                | 2                        | Tkanina I/II; Skóra -/-             | O02  | Tkanina            | Tak / Tak  | 2x 50x50 cm / Brak                         | -                                   |
| COUNTRY        | 3                        | Tkanina I/II; Skóra -/-             | O02  | Tkanina            | Tak / Tak  | 2x 50x50 cm / Brak                         | -                                   |
|                | CR 2/3                   | Tkanina I/II; Skóra -/-             | O02  | Tkanina            | Tak / Tak  | 3x 50x50 cm / Brak                         | -                                   |
|                | 1                        | Tkanina IV/II; Skóra -/-            | D00, D03, D01, D04, O02, D13, METAL                | Tkanina            | Nie / Tak  | Brak / Brak                                | -                                   |
| COZY           | 2                        | Tkanina IV/II; Skóra -/-            | D00, D03, D01, D04, O02, D13, METAL                | Tkanina            | Nie / Tak  | Brak / Brak                                | -                                   |
|                | 3                        | Tkanina IV/II; Skóra -/-            | D00, D03, D01, D04, O02, D13, METAL                | Tkanina            | Nie / Tak  | Brak / Brak                                | -                                   |
|                | 2/CHG                    | Tkanina IV/II; Skóra -/-            | D00, D03, D01, D04, O02, D13, METAL                | Tkanina            | Nie / Tak  | Brak / Brak                                | -                                   |
|                | 3/CHG                    | Tkanina IV/II; Skóra -/-            | D00, D03, D01, D04, O02, D13, METAL                | Tkanina            | Nie / Tak  | Brak / Brak                                | -                                   |
|                | CR 2/RX                  | Tkanina IV/II; Skóra -/-            | D00, D03, D01, D04, O02, D13, METAL                | Tkanina            | Nie / Tak  | Brak / Brak                                | -                                   |
|                | CR 3/RX                  | Tkanina IV/II; Skóra -/-            | D00, D03, D01, D04, O02, D13, METAL                | Tkanina            | Nie / Tak  | Brak / Brak                                | -                                   |
| CR 2/3         | Tkanina IV/II; Skóra -/- | D00, D03, D01, D04, O02, D13, METAL | Tkanina  | Nie / Tak          | Brak / Brak  | -  |                                     |
| CR 2/2/CHG     | Tkanina IV/II; Skóra -/- | D00, D03, D01, D04, O02, D13, METAL | Tkanina  | Nie / Tak          | Brak / Brak  | -  |                                     |

| MODEL                       | UKŁAD                  | WYPEŁNIENIE SIEDZISZA /OPARCE | DOSTĘPNE NOGI /KOLORYZACJE                    | DOSTĘPNE TAPICERKI | PODUSZKI SIEDZISKOWE I OPARCOWE OBRACALNE TYLKO WTKANINIE SIEDZISKOWE/OPARCE | PODUSZKA DEKORACYJNA /BOCZNA W STANDARDZIE | DODATKOWE INFORMACJE |
|-----------------------------|------------------------|-------------------------------|---|--------------------|--|--|----------------------|
| CUBA                        | 1                      | Tkanina I/II; Skóra I/II      | D00, D03, D01, D04, O02, D13                  | Tkanina / Skóra    | Tak / Nie  | Brak / Brak                                | -                    |
|                             | 1                      | Tkanina I/II; Skóra I/II      | D00, D03, D01, D04, O02, D13                  | Tkanina / Skóra    | Tak / Nie  | Brak / Brak                                | -                    |
| DAYTONA                     | 2.5                    | Tkanina I/II; Skóra I/II      | D00, D03, D01, D04, O02, D13                  | Tkanina / Skóra    | Nie / Nie  | Brak / Brak                                | -                    |
|                             | 1                      | Tkanina IV/II; Skóra -/-      | METAL-ALUMINIUM                               | Tkanina            | Tak / Tak  | Brak / 2x (53x63 cm)                       | -                    |
|                             | 2.5                    | Tkanina IV/II; Skóra -/-      | METAL-ALUMINIUM                               | Tkanina            | Tak / Tak  | Brak / 2x (53x63 cm)                       | -                    |
|                             | 3 z 2 podusz.          | Tkanina IV/II; Skóra -/-      | METAL-ALUMINIUM                               | Tkanina            | Tak / Tak  | Brak / 2x (53x63 cm)                       | -                    |
| DELPHI                      | 3 z 3 podusz.          | Tkanina IV/II; Skóra -/-      | METAL-ALUMINIUM                               | Tkanina            | Tak / Tak  | Brak / 2x (53x63 cm)                       | -                    |
|                             | 4                      | Tkanina IV/II; Skóra -/-      | METAL-ALUMINIUM                               | Tkanina            | Tak / Tak  | Brak / 2x (53x63 cm)                       | -                    |
|                             | PUF                    | Tkanina I/II; Skóra -         | METAL-ALUMINIUM                               | Tkanina            | Nie / Nie  | Brak / Brak                                | -                    |
|                             | 1                      | Tkanina I/II; Skóra -/-       | D00, D03, D01, D04, O02, D13, 3002-METAL REG. | Tkanina            | Nie / Nie  | Brak / Brak                                | -                    |
| DIANA                       | EASY                   | Tkanina I/II; Skóra -/-       | D00, D03, D01, D04, D13                       | Tkanina            | Nie / Nie  | Brak / Brak                                | -                    |
|                             | DIVA                   | Tkanina I/II; Skóra -/-       | D00, D03, D01, D04, D13                       | Tkanina            | Nie / Nie  | Brak / Brak                                | -                    |
| DIXIE                       | 1                      | Tkanina I/II; Skóra -/-       | D00, D03, D01, D04, O02, D13                  | Tkanina            | Nie / Nie  | Brak / Brak                                | -                    |
|                             | 2                      | Tkanina I/II; Skóra -/-       | D00, D03, D01, D04, O02, D13                  | Tkanina            | Nie / Nie  | Brak / Brak                                | -                    |
|                             | PUF                    | Tkanina I; Skóra -            | D00, D03, D01, D04, O02, D13                  | Tkanina            | Nie / Nie  | Brak / Brak                                | -                    |
| DOMINO                      | 1                      | Tkanina I/II; Skóra I/II      | CZARNE PVC                                    | Tkanina / Skóra    | Nie / Tak  | Brak / Brak                                | -                    |
|                             | 2                      | Tkanina I/II; Skóra -/-       | CZARNE PVC                                    | Tkanina            | Nie / Tak  | Brak / Brak                                | -                    |
|                             | 3                      | Tkanina I/II; Skóra I/II      | CZARNE PVC                                    | Tkanina / Skóra    | Nie / Tak  | Brak / Brak                                | -                    |
| ENJOY                       | CR 2/RX                | Tkanina I/II; Skóra -/-       | CZARNE PVC                                    | Tkanina            | Nie / Tak  | Brak / Brak                                | -                    |
|                             | CR 2/2.5               | Tkanina I/II; Skóra -/-       | CZARNE PVC                                    | Tkanina            | Nie / Tak  | Brak / Brak                                | -                    |
|                             | 1                      | Tkanina IV/II; Skóra -/-      | D00, D03, D01, D04, O02, D13                  | Tkanina            | Tak / Nie  | Brak / Brak                                | -                    |
| FAKTA                       | 3                      | Tkanina IV/II; Skóra -/-      | D00, D03, D01, D04, O02, D13                  | Tkanina            | Tak / Nie  | Brak / Brak                                | -                    |
|                             | PUF                    | Tkanina I/II; Skóra -         | D00, D03, D01, D04, O02, D13                  | Tkanina            | Nie / Nie  | Brak / Brak                                | -                    |
|                             | 1                      | Tkanina I/II; Skóra IV        | CZARNE PVC                                    | Tkanina / Skóra    | Nie / Tak  | Brak / Brak                                | Zaglówek X (Opcja)   |
|                             | 3F5                    | Tkanina I/II; Skóra IV        | CZARNE PVC                                    | Tkanina / Skóra    | Nie / Tak  | Brak / Brak                                | Zaglówek X (Opcja)   |
|                             | 3F5/CHG-BOX            | Tkanina I/II; Skóra IV        | CZARNE PVC                                    | Tkanina / Skóra    | Nie / Tak  | Brak / Brak                                | Zaglówek X (Opcja)   |
|                             | 3F5/RX-BOX             | Tkanina I/II; Skóra IV        | CZARNE PVC                                    | Tkanina / Skóra    | Nie / Tak  | Brak / Brak                                | Zaglówek X (Opcja)   |
| CR 2F5/2-BOX                | Tkanina I/II; Skóra IV | CZARNE PVC                    | Tkanina / Skóra                               | Nie / Tak          | Brak / Brak  | Zaglówek X (Opcja)                         |                      |
| U-SOFA (CHG-BOX)/2F5/RX-BOX | Tkanina I/II; Skóra IV | CZARNE PVC                    | Tkanina / Skóra                               | Nie / Tak          | Brak / Brak  | Zaglówek X (Opcja)                         |                      |



| MODEL     | UKŁAD                  | WYPEŁNIENIE SIEDZISZA /OPARCE | DOSTĘPNE NOGI I KOLORYZACJE                            | DOSTĘPNE TAPICERKI | PODUSZKI SIEDZISKOWE I OPARCOWE OBRACALNE TYLKO WTKANINIE SIEDZISKI/OPARCE | PODUSZKA DEKORACYJNA /BOCZNA W STANDARDZIE | DODATKOWE INFORMACJE |
|-----------|------------------------|-------------------------------|--|--------------------|--|--|----------------------|
| KINGSTON  | 3 BUE                  | Tkanina IV/II; Skóra -/ -     | O02; O02 z kolkiem srebrnym; D00, D13 z kolkiem złotym | Tkanina            | Tak / Tak  | 2x (50x50 cm) / Brak                       | -                    |
|           | CR 2/2                 | Tkanina IV/III; Skóra -/ -    | O02; O02 z kolkiem srebrnym; D00, D13 z kolkiem złotym | Tkanina            | Tak / Tak  | 2x (50x50 cm) / Brak                       | -                    |
|           | PUF                    | Tkanina IV; Skóra -           | O02; O02 z kolkiem srebrnym; D00, D13 z kolkiem złotym | Tkanina            | Nie / Nie  | Brak / Brak                                | -                    |
|           | MODUŁY STR. 37         | Tkanina IV; Skóra I/ I        | 10-METAL REG., O02, B11, B00, D13, D00, D01, D04, D03  | Tkanina / Skóra    | Tak / Tak  | Brak / Brak                                | Zagłówek X (Opcja)   |
| LILFE     | 1                      | Tkanina I/; Skóra I/ I        | METAL SATYNA   | Tkanina / Skóra    | Nie / Nie  | Brak / Brak                                | -                    |
|           | 1                      | Tkanina I/; Skóra -/ -        | D00, D13   | Tkanina            | Tak / Tak  | Brak / Brak                                | -                    |
| LINCOLN   | 2                      | Tkanina I/; Skóra I/ I        | D00, D13   | Tkanina / Skóra    | Tak / Tak  | 2x (50x50 cm) / Brak                       | -                    |
|           | 3                      | Tkanina I/; Skóra I/ I        | D00, D13   | Tkanina / Skóra    | Tak / Tak  | 2x (50x50 cm) / Brak                       | -                    |
|           | 3FS                    | Tkanina I/; Skóra I/ I        | D00, D13   | Tkanina / Skóra    | Tak / Tak  | 2x (50x50 cm) / Brak                       | -                    |
|           | CR 2/2                 | Tkanina I/; Skóra I/ I        | D00, D13   | Tkanina / Skóra    | Tak / Tak  | 3x (50x50 cm) / Brak                       | -                    |
|           | CR 3/2                 | Tkanina I/; Skóra I/ I        | D00, D13   | Tkanina / Skóra    | Tak / Tak  | 3x (50x50 cm) / Brak                       | -                    |
|           | 1                      | Tkanina I/; Skóra I/ I        | D00, O02, D13  | Tkanina / Skóra    | Tak / Nie  | Brak / Brak                                | -                    |
| LUXEMBURG | 1                      | Tkanina I/; Skóra IV/II       | B11, D13, O02, 3002-METAL REG.                         | Tkanina / Skóra    | Tak / Tak  | Brak / 2x (62x31 cm)                       | -                    |
|           | 2                      | Tkanina I/; Skóra IV/II       | B11, D13, O02, 3002-METAL REG.                         | Tkanina / Skóra    | Tak / Tak  | Brak / 2x (62x31 cm)                       | -                    |
|           | 2.5                    | Tkanina I/; Skóra IV/II       | B11, D13, O02, 3002-METAL REG.                         | Tkanina / Skóra    | Tak / Tak  | Brak / 2x (62x31 cm)                       | -                    |
|           | 3                      | Tkanina I/; Skóra IV/II       | B11, D13, O02, 3002-METAL REG.                         | Tkanina / Skóra    | Tak / Tak  | Brak / 2x (62x31 cm)                       | -                    |
| MARLIN    | CR 2/2.5               | Tkanina I/; Skóra IV/II       | B11, D13, O02, 3002-METAL REG.                         | Tkanina / Skóra    | Tak / Tak  | Brak / 2x (62x31 cm)                       | -                    |
|           | 2.5                    | Tkanina I/; Skóra -/ -        | D00, D03, D01, D04, D13                                | Tkanina            | Nie / Nie  | 2x (72x28 cm) / Brak                       | -                    |
| MEDELEY   | 3                      | Tkanina I/; Skóra -/ -        | D00, D03, D01, D04, D13                                | Tkanina            | Nie / Nie  | 2x (83x28 cm) / Brak                       | -                    |
|           | KRZESLO                | Tkanina I/; Skóra -/ -        | D00, D03, D01, D04, O02, D13                           | Tkanina            | Nie / Nie  | Brak / Brak                                | -                    |
|           | 1.5                    | Tkanina I/; Skóra -/ -        | D00, D03, D01, D04, O02, D13                           | Tkanina            | Tak / Nie  | Brak / Brak                                | -                    |
|           | 2.5                    | Tkanina I/; Skóra -/ -        | D00, D03, D01, D04, O02, D13                           | Tkanina            | Tak / Nie  | Brak / Brak                                | -                    |
|           | 3                      | Tkanina I/; Skóra -/ -        | D00, D03, D01, D04, O02, D13                           | Tkanina            | Tak / Nie  | Brak / Brak                                | -                    |
|           | 3.5                    | Tkanina I/; Skóra -/ -        | D00, D03, D01, D04, O02, D13                           | Tkanina            | Tak / Nie  | Brak / Brak                                | -                    |
| CR 3.5/2  | Tkanina I/; Skóra -/ - | D00, D03, D01, D04, O02, D13  | Tkanina  | Tak / Nie          | Brak / Brak  | -  |                      |

| MODEL    | UKŁAD                         | WYPEŁNIENIE SIEDZISZA /OPARCE                          | DOSTĘPNE NOGI I KOLORYZACJE                            | DOSTĘPNE TAPICERKI | PODUSZKI SIEDZISKOWE I OPARCOWE OBRACALNE TYLKO WTKANINIE SIEDZISKI/OPARCE | PODUSZKA DEKORACYJNA /BOCZNA W STANDARDZIE | DODATKOWE INFORMACJE |
|----------|-------------------------------|--|--|--------------------|--|--|----------------------|
| FORELE   | 1                             | Tkanina I/; Skóra I/ I                                 | METAL ALUMINIUM  | Tkanina / Skóra    | Nie / Nie  | Brak / Brak                                | -                    |
|          | 2                             | Tkanina I/; Skóra I/ I                                 | METAL ALUMINIUM  | Tkanina / Skóra    | Nie / Nie  | Brak / Brak                                | -                    |
|          | 3                             | Tkanina I/; Skóra I/ I                                 | METAL ALUMINIUM  | Tkanina / Skóra    | Nie / Nie  | Brak / Brak                                | -                    |
|          | 3.5                           | Tkanina I/; Skóra I/ I                                 | METAL ALUMINIUM  | Tkanina / Skóra    | Nie / Nie  | Brak / Brak                                | -                    |
| FUNKI    | 4                             | Tkanina I/; Skóra I/ I                                 | METAL ALUMINIUM  | Tkanina / Skóra    | Nie / Nie  | Brak / Brak                                | -                    |
|          | CR 3/RX                       | Tkanina I/; Skóra I/ I                                 | METAL ALUMINIUM  | Tkanina / Skóra    | Nie / Nie  | Brak / Brak                                | -                    |
|          | 1                             | Tkanina IV; Skóra IV                                   | CZARNE PVC   | Tkanina / Skóra    | Nie / Tak  | Brak / Brak                                | Zagłówek X (Opcja)   |
|          | 3FS; CHG-BOX                  | Tkanina IV; Skóra IV                                   | CZARNE PVC   | Tkanina / Skóra    | Nie / Tak  | Brak / Brak                                | Zagłówek X (Opcja)   |
| GEORGE   | 3FS; RX-BOX                   | Tkanina IV; Skóra IV                                   | CZARNE PVC   | Tkanina / Skóra    | Nie / Tak  | Brak / Brak                                | Zagłówek X (Opcja)   |
|          | CR 2FS/ 2-BOX                 | Tkanina IV; Skóra IV                                   | CZARNE PVC   | Tkanina / Skóra    | Nie / Tak  | Brak / Brak                                | Zagłówek X (Opcja)   |
|          | U-SOFA (CHG-BOX)/2FS (RX-BOX) | Tkanina IV; Skóra IV                                   | CZARNE PVC   | Tkanina / Skóra    | Nie / Tak  | Brak / Brak                                | Zagłówek X (Opcja)   |
|          | 1                             | Tkanina IV/; Skóra IV/ I                               | D00, D03, D01, D04, O02, D13; O02 z kolkiem srebrnym   | Tkanina / Skóra    | Tak / Nie  | Brak / Brak                                | -                    |
| GIPSY    | 1                             | Tkanina I/; Skóra I/ I                                 | D00, O02   | Tkanina / Skóra    | Tak / Tak  | Brak / Brak                                | -                    |
|          | 2                             | Tkanina I/; Skóra I/ I                                 | D00, O02   | Tkanina / Skóra    | Tak / Tak  | Brak / Brak                                | -                    |
|          | 3                             | Tkanina I/; Skóra I/ I                                 | D00, O02   | Tkanina / Skóra    | Tak / Tak  | Brak / Brak                                | -                    |
| JEDO     | PUF                           | Tkanina I; Skóra I                                     | D00, O02   | Tkanina / Skóra    | Nie / Nie  | Brak / Brak                                | -                    |
|          | 1                             | Tkanina I/; Skóra I/ I                                 | D00, O02, D13  | Tkanina / Skóra    | Tak / Nie  | Brak / Brak                                | -                    |
| KINGSTON | 1                             | Tkanina IV/III; Skóra -/ -                             | O02; O02 z kolkiem srebrnym; D00, D13 z kolkiem złotym | Tkanina            | Tak / Tak  | Brak / Brak                                | -                    |
|          | CHG                           | Tkanina IV/III; Skóra -/ -                             | O02; O02 z kolkiem srebrnym; D00, D13 z kolkiem złotym | Tkanina            | Tak / Tak  | Brak / Brak                                | -                    |
|          | 2                             | Tkanina IV/III; Skóra -/ -                             | O02; O02 z kolkiem srebrnym; D00, D13 z kolkiem złotym | Tkanina            | Tak / Tak  | 2x (50x50 cm) / Brak                       | -                    |
| 3        | Tkanina IV/III; Skóra -/ -    | O02; O02 z kolkiem srebrnym; D00, D13 z kolkiem złotym | Tkanina  | Tak / Tak          | 2x (50x50 cm) / Brak   | -  |                      |

| MODEL  | UKŁAD         | WYPELNIENIE SIĘDZISKO / OPARCIE | DOSTĘPNE NOGI / KOLORYZACJE                                  | DOSTĘPNE TAPICERKI | PODUSZKI SIĘDZISKOWE I OPARCOWE OBRACALNE TYLKO W TKANINNE SIĘDZISKO / OPARCIE | PODUSZKA DEKORACYJNA / BOCZNA W STANDARDZIE | DODATKOWE INFORMACJE:   |
|--------|---------------|---------------------------------|--|--------------------|--|---|---|
| MEMORY | 2             | Tkanina I/II; Skóra I/II        | D00, O02, D13  | Tkanina / Skóra    | Nie / Tak  | Brak / 2x (60X33 cm)                        | -   |
|        | 2.5           | Tkanina I/II; Skóra I/II        | D00, O02, D13  | Tkanina / Skóra    | Nie / Tak  | Brak / 2x (60X33 cm)                        | -   |
|        | 3             | Tkanina I/II; Skóra I/II        | D00, O02, D13  | Tkanina / Skóra    | Nie / Tak  | Brak / 2x (60X33 cm)                        | -   |
| MIAMI  | CR23          | Tkanina I/II; Skóra I/II        | D00, O02, D13  | Tkanina / Skóra    | Nie / Tak  | Brak / 2x (60X33 cm)                        | -   |
|        | 1             | Tkanina I/II; Skóra I/II        | OILCHA SUROWA O14  | Tkanina            | Tak / Tak  | Brak / Brak                                 | -   |
|        | 2             | Tkanina I/II; Skóra I/II        | OILCHA SUROWA O14  | Tkanina            | Tak / Tak  | 2x (45x45 cm) / Brak                        | -   |
| MOLLY  | 3             | Tkanina I/II; Skóra I/II        | OILCHA SUROWA O14  | Tkanina            | Tak / Tak  | 2x (45x45 cm) / Brak                        | -   |
|        | 3FS           | Tkanina I/II; Skóra I/II        | OILCHA SUROWA O14  | Tkanina            | Tak / Tak  | 2x (45x45 cm) / Brak                        | -   |
|        | CR22          | Tkanina I/II; Skóra I/II        | OILCHA SUROWA O14  | Tkanina            | Tak / Tak  | 3x (45x45 cm) / Brak                        | -   |
| MONROE | CR23          | Tkanina I/II; Skóra I/II        | OILCHA SUROWA O14  | Tkanina            | Tak / Tak  | 3x (45x45 cm) / Brak                        | -   |
|        | 1             | Tkanina I/II; Skóra I/II        | D00, D03, D01, D04, O02, D13                                 | Tkanina            | Tak / Nie  | Brak / Brak                                 | -   |
|        | 3             | Tkanina I/II; Skóra I/II        | D00, D03, D01, D04, O02, D13                                 | Tkanina            | Tak / Nie  | Brak / Brak                                 | -   |
| NINA   | PUF           | Tkanina I/II; Skóra I/II        | D00, D03, D01, D04, O02, D13                                 | Tkanina            | Nie / Nie  | Brak / Brak                                 | -   |
|        | KRZESLO       | Tkanina I/II; Skóra I/II        | D00, D03, D01, D04, O02, D13                                 | Tkanina            | Nie / Nie  | Brak / Brak                                 | -   |
|        | 1,5           | Tkanina I/II; Skóra I/II        | D00, D03, D01, D04, O02, D13                                 | Tkanina            | Tak / Nie  | Brak / Brak                                 | -   |
| NOVA   | 2,5           | Tkanina I/II; Skóra I/II        | D00, D03, D01, D04, O02, D13                                 | Tkanina            | Tak / Nie  | Brak / Brak                                 | -   |
|        | 3             | Tkanina I/II; Skóra I/II        | D00, D03, D01, D04, O02, D13                                 | Tkanina            | Tak / Nie  | Brak / Brak                                 | -   |
|        | 3,5           | Tkanina I/II; Skóra I/II        | D00, D03, D01, D04, O02, D13                                 | Tkanina            | Tak / Nie  | Brak / Brak                                 | -   |
| OLIVA  | CR 3,5/2      | Tkanina I/II; Skóra I/II        | D00, D03, D01, D04, O02, D13                                 | Tkanina            | Tak / Nie  | Brak / Brak                                 | -   |
|        | 1             | Tkanina I/II; Skóra I/II        | D00, D03, D01, D04, O02, D13, 3002-METAL-REG.                | Tkanina / Skóra    | Nie / Nie  | Brak / Brak                                 | -   |
|        | KRZESLO       | Tkanina I/II; Skóra I/II        | D00, D03, D01, D04, O02, D13                                 | Tkanina            | Nie / Nie  | Brak / Brak                                 | -   |
| PAERMO | 1             | Tkanina I/II; Skóra I/II        | D00, D03, D01, D04, O02, D13, 10-METAL-REG.                  | Tkanina / Skóra    | Nie / Nie  | Brak / Brak                                 | -   |
|        | MODULY STR-43 | Tkanina I/II; Skóra I/II        | B11, B00, D13, D00, O02, D01, D04, D03, PVC, 3002-METAL-REG. | Tkanina / Skóra    | Tak / Tak  | Informacja na stronie 43                    | DUN-TOP siedzisko / oparcie; Zagłówek X; Zagłówek X3; Zagłówek X7 (Opcje) |
|        | 3FS           | Tkanina I/II; Skóra I/II        | PVC CZARNA   | Tkanina            | Nie / Nie  | 2x (45x45 cm) / Brak                        | -   |
| RETRO  | 2,5           | Tkanina I/II; Skóra I/II        | D00, D03, D01, D04, O02, D13                                 | Tkanina / Skóra    | Tak / Tak  | Brak / Brak                                 | -   |
|        | 3             | Tkanina I/II; Skóra I/II        | D00, D03, D01, D04, O02, D13                                 | Tkanina / Skóra    | Tak / Tak  | Brak / Brak                                 | -   |

| MODEL   | UKŁAD         | WYPELNIENIE SIĘDZISKO / OPARCIE | DOSTĘPNE NOGI / KOLORYZACJE                               | DOSTĘPNE TAPICERKI | PODUSZKI SIĘDZISKOWE OBRACALNE TYLKO W TKANINNE SIĘDZISKO / OPARCIE | PODUSZKA DEKORACYJNA / BOCZNA W STANDARDZIE | DODATKOWE INFORMACJE:                            |
|---------|---------------|---------------------------------|---|--------------------|---|---|--|
| SKAMELE | MINI 40       | Tkanina I/-; Skóra I            | CZARNE PVC  | Tkanina / Skóra    | Nie / Nie   | Brak / Brak                                 | Pojemnik   |
|         | MIDI 80       | Tkanina I; Skóra I              | CZARNE PVC  | Tkanina / Skóra    | Nie / Nie   | Brak / Brak                                 | Pojemnik   |
|         | Glass Puf 48  | Tkanina I; Skóra I              | O02   | Tkanina / Skóra    | Nie / Nie   | Brak / Brak                                 | Wyciągana szyba                                  |
|         | Gull Puf 48   | Tkanina I; Skóra I              | O02   | Tkanina / Skóra    | Nie / Nie   | Brak / Brak                                 | -  |
|         | Glass Puf 60  | Tkanina I; Skóra I              | O02   | Tkanina / Skóra    | Nie / Nie   | Brak / Brak                                 | Wyciągana szyba                                  |
|         | Glass Puf 80W | Tkanina I; Skóra I              | O02   | Tkanina / Skóra    | Nie / Nie   | Brak / Brak                                 | Wyciągana szyba                                  |
|         | Indiagma      | Tkanina I; Skóra I              | O02, D13, CZARNE PVC                                      | Tkanina / Skóra    | Nie / Nie   | Brak / Brak                                 | -  |
|         | 2FS           | Tkanina I/II; Skóra I/-         | D00, D03, D01, D04, O02, D13, 3002-METAL-REG., 3011 METAL | Tkanina            | Tak / Tak   | Brak / Brak                                 | DUN-TOP siedzisko / oparcie; Zagłówek X3 (Opcja) |
| TOKYO   | 2,5FS         | Tkanina I/II; Skóra I/-         | D00, D03, D01, D04, O02, D13, 3002-METAL-REG., 3011 METAL | Tkanina            | Tak / Tak   | Brak / Brak                                 | DUN-TOP siedzisko / oparcie; Zagłówek X3 (Opcja) |
|         | 3FS           | Tkanina I/II; Skóra I/-         | D00, D03, D01, D04, O02, D13, 3002-METAL-REG., 3011 METAL | Tkanina            | Tak / Tak   | Brak / Brak                                 | DUN-TOP siedzisko / oparcie; Zagłówek X3 (Opcja) |
|         | 2FS/CHG       | Tkanina I/II; Skóra I/-         | D00, D03, D01, D04, O02, D13, 3002-METAL-REG., 3011 METAL | Tkanina            | Tak / Tak   | Brak / Brak                                 | DUN-TOP siedzisko / oparcie; Zagłówek X3 (Opcja) |
|         | 2,5FS/CHG     | Tkanina I/II; Skóra I/-         | D00, D03, D01, D04, O02, D13, 3002-METAL-REG., 3011 METAL | Tkanina            | Tak / Tak   | Brak / Brak                                 | DUN-TOP siedzisko / oparcie; Zagłówek X3 (Opcja) |
|         | 3FS/CHG       | Tkanina I/II; Skóra I/-         | D00, D03, D01, D04, O02, D13, 3002-METAL-REG., 3011 METAL | Tkanina            | Tak / Tak   | Brak / Brak                                 | DUN-TOP siedzisko / oparcie; Zagłówek X3 (Opcja) |
|         | CR 2FS/RX     | Tkanina I/II; Skóra I/-         | D00, D03, D01, D04, O02, D13, 3002-METAL-REG., 3011 METAL | Tkanina            | Tak / Tak   | Brak / Brak                                 | DUN-TOP siedzisko / oparcie; Zagłówek X3 (Opcja) |
|         | CR 2,5FS/RX   | Tkanina I/II; Skóra I/-         | D00, D03, D01, D04, O02, D13, 3002-METAL-REG., 3011 METAL | Tkanina            | Tak / Tak   | Brak / Brak                                 | DUN-TOP siedzisko / oparcie; Zagłówek X3 (Opcja) |
|         | CR 3FS/RX     | Tkanina I/II; Skóra I/-         | D00, D03, D01, D04, O02, D13, 3002-METAL-REG., 3011 METAL | Tkanina            | Tak / Tak   | Brak / Brak                                 | DUN-TOP siedzisko / oparcie; Zagłówek X3 (Opcja) |
|         | CR 2FS/2      | Tkanina I/II; Skóra I/-         | D00, D03, D01, D04, O02, D13, 3002-METAL-REG., 3011 METAL | Tkanina            | Tak / Tak   | Brak / Brak                                 | DUN-TOP siedzisko / oparcie; Zagłówek X3 (Opcja) |
|         | CR 2FS/2,5    | Tkanina I/II; Skóra I/-         | D00, D03, D01, D04, O02, D13, 3002-METAL-REG., 3011 METAL | Tkanina            | Tak / Tak   | Brak / Brak                                 | DUN-TOP siedzisko / oparcie; Zagłówek X3 (Opcja) |
|         | CR 2FS/3      | Tkanina I/II; Skóra I/-         | D00, D03, D01, D04, O02, D13, 3002-METAL-REG., 3011 METAL | Tkanina            | Tak / Tak   | Brak / Brak                                 | DUN-TOP siedzisko / oparcie; Zagłówek X3 (Opcja) |

| MODEL   | UKŁAD      | WYPEŁNIENIE SIEDZISKA / OPARCIE | DOSTĘPNE NOGI I KOLORYZACJE  | DOSTĘPNE TAPICERKI | PODUSZKI SIEDZISKOWE I OPARCOWE OBRACALNE TYLKO W TKANINIE SIEDZISKOWO OPARCIE | PODUSZKA DEGRACYJNA / BOCZNA W STANDARDZIE | DODATKOWE INFORMACJE |
|---------|------------|---------------------------------|------------------------------|--------------------|--|--|----------------------|
| VIENN   | 1 Z BOKIEM | Tkanina I/; Skóra I/            | D00, D03, D01, D04, O02, D13 | Tkanina / Skóra    | Nie/ Nie   | Brak/ Brak                                 | -                    |
|         | 1 BEZ BOKU | Tkanina II/; Skóra I/           | D00, D03, D01, D04, O02, D13 | Tkanina / Skóra    | Nie/ Nie   | Brak/ Brak                                 | -                    |
| WESTHAM | 1          | Tkanina I/ Skóra I/             | METAL ALUMINIUM              | Tkanina / Skóra    | Nie/ Nie   | Brak/ Brak                                 | -                    |
|         | 1          | Tkanina IV/III Skóra IV/III     | D00, D03, D01, D04, O02, D13 | Tkanina / Skóra    | Tak / Tak  | 1xP2 (47x47 cm) / Brak                     | -                    |
|         | 2          | Tkanina IV/III Skóra IV/III     | D00, D03, D01, D04, O02, D13 | Tkanina / Skóra    | Tak / Tak  | 2xP2 (47x47 cm) / Brak                     | -                    |
|         | 3          | Tkanina IV/III Skóra IV/III     | D00, D03, D01, D04, O02, D13 | Tkanina / Skóra    | Tak / Tak  | 2xP2 (47x47 cm) / Brak                     | -                    |
|         | 3XL        | Tkanina IV/III Skóra IV/III     | D00, D03, D01, D04, O02, D13 | Tkanina / Skóra    | Tak / Tak  | 2xP2 (47x47 cm) / Brak                     | -                    |
|         | 3XL-KRAK   | Tkanina IV/III Skóra -/         | D00, D03, D01, D04, O02, D13 | Tkanina            | Tak / Tak  | 2xP2 (47x47 cm) / Brak                     | -                    |
|         | CR 2/3     | Tkanina IV/III Skóra IV/III     | D00, D03, D01, D04, O02, D13 | Tkanina / Skóra    | Tak / Tak  | 3xP2 (47x47 cm) / Brak                     | -                    |
|         | PUF        | Tkanina IV Skóra IV             | D00, D03, D01, D04, O02, D13 | Tkanina / Skóra    | Nie/ Nie   | Brak/ Brak                                 | -                    |

| MODEL  | UKŁAD          | WYPEŁNIENIE SIEDZISKA / OPARCIE | DOSTĘPNE NOGI I KOLORYZACJE   | DOSTĘPNE TAPICERKI | PODUSZKI SIEDZISKOWE I OPARCOWE OBRACALNE TYLKO W TKANINIE SIEDZISKOWO OPARCIE | PODUSZKA DEGRACYJNA / BOCZNA W STANDARDZIE | DODATKOWE INFORMACJE   |
|--------|----------------|---------------------------------|---|--------------------|--|--|--|
| TOKYO  | CR 2.5F5 /Z    | Tkanina I/; Skóra -/            | D00, D03, D01, D04, O02, D13, 3002-METAL REG., 3011 METAL   | Tkanina            | Tak / Tak  | Brak / Brak                                | DUN-TOP siedzisko / oparcie; Zagłówek X3 (Opcja)                 |
|        | CR 2.5F5 /Z.5  | Tkanina I/; Skóra -/            | D00, D03, D01, D04, O02, D13, 3002-METAL REG., 3011 METAL   | Tkanina            | Tak / Tak  | Brak / Brak                                | DUN-TOP siedzisko / oparcie; Zagłówek X3 (Opcja)                 |
|        | CR 2.5F5/3     | Tkanina I/; Skóra -/            | D00, D03, D01, D04, O02, D13, 3002-METAL REG., 3011 METAL   | Tkanina            | Tak / Tak  | Brak / Brak                                | DUN-TOP siedzisko / oparcie; Zagłówek X3 (Opcja)                 |
|        | CR 3F5/2       | Tkanina I/; Skóra -/            | D00, D03, D01, D04, O02, D13, 3002-METAL REG., 3011 METAL   | Tkanina            | Tak / Tak  | Brak / Brak                                | DUN-TOP siedzisko / oparcie; Zagłówek X3 (Opcja)                 |
|        | CR 3F5/2.5     | Tkanina I/; Skóra -/            | D00, D03, D01, D04, O02, D13, 3002-METAL REG., 3011 METAL   | Tkanina            | Tak / Tak  | Brak / Brak                                | DUN-TOP siedzisko / oparcie; Zagłówek X3 (Opcja)                 |
|        | CR 3F5/3       | Tkanina I/; Skóra -/            | D00, D03, D01, D04, O02, D13, 3002-METAL REG., 3011 METAL   | Tkanina            | Tak / Tak  | Brak / Brak                                | DUN-TOP siedzisko / oparcie; Zagłówek X3 (Opcja)                 |
|        | PUF B          | Tkanina I; Skóra -              | D00, D03, D01, D04, O02, D13, 3002-METAL REG., 3011 METAL   | Tkanina            | Nie/ Nie   | Brak / Brak                                | DUN-TOP siedzisko / oparcie; Zagłówek X3 (Opcja)                 |
| TULIP  | PUF B1         | Tkanina I; Skóra -              | D00, D03, D01, D04, O02, D13, 3002-METAL REG., 3011 METAL   | Tkanina            | Nie/ Nie   | Brak / Brak                                | DUN-TOP siedzisko / oparcie; Zagłówek X3 (Opcja)                 |
|        | PUF B2         | Tkanina I; Skóra -              | D00, D03, D01, D04, O02, D13, 3002-METAL REG., 3011 METAL   | Tkanina            | Nie/ Nie   | Brak / Brak                                | DUN-TOP siedzisko / oparcie; Zagłówek X3 (Opcja)                 |
|        | 1              | Tkanina I/; Skóra I/            | METAL SATYNA  | Tkanina / Skóra    | Nie/ Nie   | Brak / Brak                                | -  |
| VEGA   | 2.5            | Tkanina I/; Skóra -/            | D00, D03, D01, D04, O02, D13  | Tkanina            | Tak / Tak  | Brak / 2x (59x27 cm)                       | -  |
|        | 3              | Tkanina I/; Skóra -/            | D00, D03, D01, D04, O02, D13  | Tkanina            | Tak / Tak  | Brak / 2x (59x27 cm)                       | -  |
| VERONA | MODUŁY STR. 39 | Tkanina I/; Skóra I/            | METAL ALUMINIUM, METAL CHROM, 10-METAL REG., METAL ALUMINIUM, O02, B11, 800, D13, D00, D01, D04, D03, B11 | Tkanina / Skóra    | Tak / Tak  | Informacja na stronie 39                   | DUN-TOP siedzisko / oparcie; Zagłówek X Zagłówek X3, Zagłówek X7 |

*Niniejszy katalog nie stanowi oferty w rozumieniu prawnym i jest publikowany jedynie w celu informacyjnym. Producent zastrzega sobie prawo do wykonywania zmian konstrukcyjnych w opracowanych meblach, nie zmieniając ich ogólnego charakteru. Wszystkie wymiary podane są w cm z tolerancją +/-2cm.*

*Ze względu na ograniczenia wynikające z techniki druku, kolory reproduktowane w katalogu mogą się różnić od rzeczywistych kolorów oferowanych mebli oraz koloryzacji wybarwień nóg.*



## WYŁĄCZNY DYSTRYBUTOR

Nordic Line Sp. z o.o.  
62 – 800 Kalisz, Poland  
[www.nordicline.pl](http://www.nordicline.pl)  
[biuro@nordicline.pl](mailto:biuro@nordicline.pl)